

OT128

128-Channel Mechanical Lidar User Manual

Classification: Public

Doc Version: 001-en-240910

Table of Contents

■ About this manual	1
Access to this manual	1
Technical support	1
Legends and format	1
■ Safety notice	2
Special warnings	2
Operating environment	3
Personnel	5
Installation and operation	5
Repair	9
1. Introduction	10
1.1. Applicability	10
1.2. Operating principle	10
1.3. Basic structure	11
1.4. Channel distribution	12
1.5. Laser firing position	13
1.6. Specifications	15
2. Setup	18
2.1. Mechanical installation	18
2.1.1. Exterior dimensions	18
2.1.2. Recommended Installation	23
2.1.3. Notes on screw installation	24
2.2. Electrical interface	25
2.2.1. Pin description	25
2.2.2. Connector use	27

2.2.3. Cables (Ethernet)	28
2.3. Connection box (optional)	29
2.3.1. Ports	31
2.3.2. Connection	34
2.4. Network settings on the receiving host	36
2.4.1. In Windows	37
2.4.2. In Ubuntu	40
2.5. Tools	43
3. Data structure	44
3.1. Point Cloud Data Packet	45
3.1.1. Ethernet header	45
3.1.2. Point cloud UDP data	46
3.1.3. Ethernet tail	56
3.1.4. Point cloud data analysis method	57
4. Parameter interfaces	60
4.1. Network connection	60
4.1.1. Source	60
4.1.2. Destination	62
4.2. Functional settings	63
4.3. State settings	68
4.4. Time sync	69
4.5. Lidar info	70
4.6. Operation statistics	71
4.7. Upgrade	71
4.8. Logs	71
5. Communication protocol	73
6. Maintenance	74

7. Troubleshooting	76
Appendix A: Channel distribution data	80
Appendix B: Absolute time of point cloud data	89
B.1. Source of absolute time	89
B.1.1. PTP as the clock source	89
B.2. Absolute time of Point Cloud Data Packets	90
B.3. Start time of each block	90
B.4. Laser firing time of each channel	92
Appendix C: Nonlinear reflectivity mapping	101
C.1. Nonlinear Mapping 1#	101
C.2. Nonlinear mapping 2#	106
Appendix D: Legal notice	111

■ About this manual

Please make sure to read through this user manual before your first use and follow the instructions herein when you operate the product. Failure to comply with the instructions may result in product damage, property loss, personal injuries, and/or a breach of warranty.

Access to this manual

To obtain the latest version, please do one of the following:

- Visit the Download page of Hesai's official website: <https://www.hesaitech.com/downloads/>
- Contact your sales representative of Hesai.
- Contact Hesai technical support: service@hesaitech.com

Technical support

If your question is not addressed in this user manual, please contact us at:

- service@hesaitech.com
- <https://www.hesaitech.com/technical-support/>
- <https://github.com/HesaiTechnology>

Legends and format

 **Warnings:** Instructions that must be followed to ensure safe and proper use of the product.

 **Notes:** Additional information that may be helpful.

Monospace font: field names

For example: **Distance** represents the Distance field.

■ Safety notice

- Please make sure to read through this safety notice and follow all the instructions and warnings. Failure to comply with the instructions and warnings may result in product damage, property loss, and/or personal injuries.
- Please check the certification information on the product's nameplate and read through the corresponding certification warnings. If specific users require not presenting certification information on the nameplate, please follow the agreed-to arrangements.
- If you incorporate this lidar product into your product(s), you are required to provide this user manual (or access to this user manual) to the intended users of your product(s).
- This lidar product is intended as a component of an end product. It is the responsibility of the end-product supplier to assess the risk of use in accordance with applicable standards and inform the intended user of safety-related information.
- Should there be other agreements with specific users, the other agreements shall apply.
- Before using a product, please confirm with Hesai the development maturity of the product in a timely manner. For products still in development, Hesai makes no warranty of non-infringement nor assumes any responsibility for quality assurance.

Special warnings

Laser safety

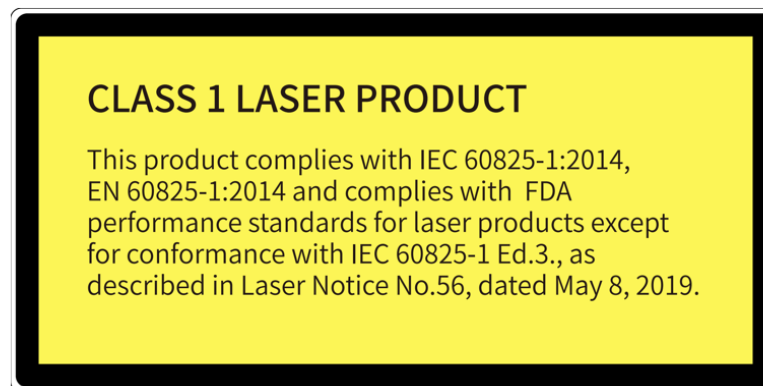

Hot surface



Hot parts!

Burned fingers when handling the parts.

Wait one-half hour after switching off before handling the parts.

Abnormalities

In any of the circumstances listed below, stop using the product immediately:

- If you suspect malfunctions of or damage to the product, with symptoms such as significant noise or visible vibration.
- If you or people in the nearby environment feel discomfort.
- If any device or equipment in the nearby environment malfunctions.

Meanwhile, contact Hesai or an authorized Hesai service provider for more information on product disposal.

Prohibition of disassembly

Unless expressly agreed to in writing by Hesai, do NOT disassemble the product.

Operating environment

Radio frequency (RF) interference

- Before using the product, make sure to read all the signs and notices on the product enclosure (including the nameplate). If specific users require not presenting certification information on the nameplate, please follow the agreed-to arrangements.
- Although the product is designed, tested, and manufactured to comply with the regulations on RF radiation (such as FCC, CE-EMC, or KCC), the radiation from the product may still influence electronic devices.

Vibration

- If significant mechanical shocks and vibration exist in the product's operating environment, please contact Hesai's technical support to obtain the shock and vibration limits of your product model. Exposure to over-the-limit shocks or vibration may damage the product.
- Make sure to package the product in shock-proof materials to avoid damage during transport.

Explosive atmosphere and other air conditions

- Do NOT use the product in any area where potentially explosive atmospheres are present, such as environments with high concentrations of flammable chemicals, vapors, or particulates (including particles, dust, and metal powder) in the air.
- Do NOT expose the product to environments having high concentrations of industrial chemicals, including liquefied gases that are easily vaporized (such as helium). Such exposure can damage or impair product functionality.

Chemical environment

Do NOT expose the product to corrosive or strong polar chemical environments (such as liquids or gases), including but not limited to strong acids, strong bases, esters, and ethers. This is to avoid damage to the product (including but not limited to water resistance failure).

Ingress protection (IP)

Please check the product's user manual for its IP rating (refer to [Section 1.6 Specifications](#)). Make sure to avoid any ingress beyond that rating.

Operating temperature

Please check the product's user manual for its operating temperature (refer to [Section 1.6 Specifications](#)). Make sure not to exceed the operating temperature range.

Recommended storage conditions

Please store the product in a dry and well-ventilated place. The recommended ambient temperature is $23 \pm 5^{\circ}\text{C}$, and the humidity is between 30% and 70%.

Light interference

Certain precision optical instruments may interfere with the laser light emitted from the product. Please check all the instructions for these instruments and take preventive measures if necessary. For example, protective leather covers are provided for certain product models; when these lidars are temporarily not used for measurement, the leather covers can be applied to block laser light emission.

Personnel

Recommended operator qualifications

The product should be operated by professionals with engineering backgrounds or experience in operating optical, electrical, and mechanical instruments. Please follow the instructions in this manual when operating the product and contact Hesai technical support if needed.

Medical device interference

- Some components in the product can emit electromagnetic fields. If the product operators or people in the nearby environment wear medical devices (such as cochlear implants, implanted pacemakers, and defibrillators), make sure to consult the physicians and medical device manufacturers for medical advice, such as determining whether keeping the product a safe distance away from the medical devices is needed.
- If you suspect that the product is interfering with your medical device, stop using the product immediately.

Installation and operation

Power supply

- Before powering on the product, make sure the electrical interfaces are dry and clean. Do NOT power on the product in humid conditions.
- Do NOT use out-of-spec or damaged cables or adapters.
- You are recommended to use only the cables and power adapters provided by Hesai. If you are to design, configure, or select the power supply system (including cables) for the product, make sure to comply with the electrical specifications in the product's user manual (refer to [Section 1.6 Specifications](#) and the Power Supply Requirements section if available); for technical support, please contact Hesai.
- Please check [Section 2.2 Electrical interface](#) and strictly follow the instructions on plugging/unplugging the connector. If abnormalities already exist (such as bent pins, broken cables, and loose screws), stop using the product and contact Hesai technical support.

Eye safety

The product is a Class 1 laser product. It satisfies the requirements of:

- IEC 60825-1:2014
- EN 60825-1:2014
- 21 CFR 1040.10 and 1040.11 except for deviations (IEC 60825-1 Ed.3) pursuant to Laser Notice No.56, dated May 8, 2019.

CAUTION: Use of controls or adjustments or performance of procedures other than those specified herein may result in hazardous radiation exposure.

CAUTION

- For maximum self-protection, it is strongly warned that users do NOT look into the transmitting laser through a magnifying product (microscope, eye loupe, magnifying glass, etc.).
- This product does not have a power switch. It starts operating once connected to power. During operation, the entire cover lens can be regarded as the product's laser emitting window; looking at the cover lens can be regarded as looking into transmitting laser.

Product enclosure

- The product contains metal, glass, plastic, as well as sensitive electronic components. If the product is dropped or burnt, stop using it immediately and contact Hesai technical support.
- Do NOT squeeze or pierce the product. If the product enclosure is broken, stop using it immediately and contact Hesai technical support.
- Certain product models contain high-speed rotating parts. To avoid potential injuries, do NOT operate the product if the enclosure is loose.
- If the product enclosure consists of fins or grooves, please wear gloves when handling the product. Applying too much pressure with your bare hands may cause cuts, bruises or other injuries.

Cover lens

 The location of the cover lens is illustrated in [Section 1 Introduction](#).

- Do NOT apply protective film, wax or any other substance on the cover lens.
- To keep the product's cover lens from fingerprints and other stains, do NOT touch the cover lens with bare hands. If the cover lens is already stained, please refer to the cleaning method in [Section 6 Maintenance](#).
- To prevent scratches, do NOT touch the product's cover lens with hard or sharp objects. If scratches already exist, stop using the product and contact Hesai technical support. Severe scratches may affect the quality of the product's point cloud data.

Mounting

- Before operating the product, make sure it is properly and securely mounted. The mounting should prevent the product from leaving its mounting position under external forces (such as collisions, high winds, and stone impacts).
- Before installing any exterior part, please ensure that each exterior part and its movable area do not overlap the Field of View (FOV) of the lidar.

 The FOV of lidar is the spatial angular range bounded by the horizontal and vertical FOV ranges (see [Section 1.6 Specifications](#)); the distance to the origin of the lidar's coordinate system is not limited. For inquiries about the FOV, please contact Hesai technical support.

Hot surface

During operation or the time period after the operation, the product's enclosure can be hot.

- To prevent discomfort or even burns, do NOT touch the product's enclosure with your skin.
- To prevent fires, make sure to keep flammable materials away from the product's enclosure.

Certain product models support active heating of the cover lens to reduce the impact of ice and frost.

- While active heating is ON, please avoid direct skin contact with the cover lens.
- Users can turn off active heating.

Peripherals

The product may be used along with accessories and devices, such as suction cup mounts, extension cables, power supplies, network devices, GPS/PTP devices, CAN transceivers, and cleaning equipment.

When selecting a peripheral, please refer to all relevant specifications in the product's user manual or contact Hesai technical support. Using out-of-spec or unsuitable devices may result in product damage or even personal injuries.

Firmware and software upgrading

Make sure to use only the upgrade files provided by Hesai. Make sure to observe all the instructions provided for that upgrade file.

Customized firmware and software

- Before using a customized version of firmware and software, please fully understand the differences in functions and performance between the customized version and the standard version.
- Make sure to strictly follow all the instructions and safety precautions provided for that customized version. If the product does not function as anticipated, stop using the product immediately and contact Hesai technical support.

Point cloud data processing

- Certain product models support one or more point cloud data processing functions, including but not limited to: Noise Filtering, Interstitial Points Filtering, Retro Multi-Reflection Filtering, and Non-Linear Reflectivity Mapping.
- These functions are configurable and are intended only to assist the user in extracting information from the point cloud data. Users are in full control of whether to use any of these functions. Moreover, users are responsible for analyzing the product's intended application scenarios and evaluating the risk of enabling one or more of these functions in combination.
- To learn about the supported functions of a product model, please contact Hesai technical support.

Repair

- Unless expressly agreed to in writing by Hesai, do NOT disassemble, repair, modify, or retrofit the product by yourself or entrust any third party to do so. Such a breach:
 - can result in product damage (including but not limited to water resistance failure), property loss, and/or injuries;
 - shall constitute a breach of warranty.
- For more product repair issues, please contact Hesai or an authorized Hesai service provider.

1. Introduction

1.1. Applicability

This manual applies to the following versions:

Software	1.4.02a or later
Firmware of Sensor	1.4.1t10 or later
Firmware of Controller	1.4.1t3 or later

1.2. Operating principle

Distance measurement: Time of Flight (ToF)

1. A laser diode emits a beam of ultrashort laser pulses onto the target object.
2. The laser pulses are reflected after hitting the target object. The returning beam is detected by an optical sensor.
3. Distance to the object can be accurately measured by calculating the time between laser emission and receipt.

$$d = \frac{ct}{2}$$

d: Distance

c: Speed of light

t: Travel time of the laser beam

1.3. Basic structure

The basic structure is shown below.

Multiple pairs of laser emitters and receivers are attached to a motor that rotates 360° horizontally.

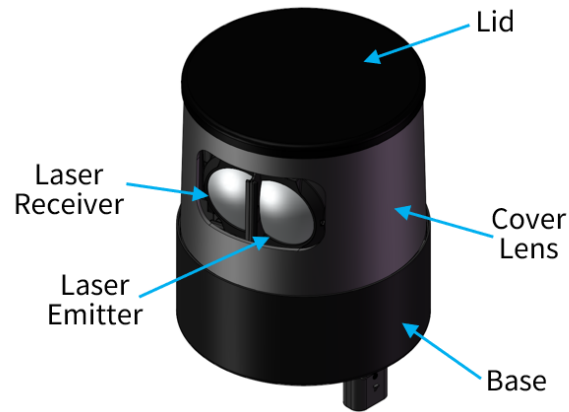

Figure 1. Partial cross-sectional diagram

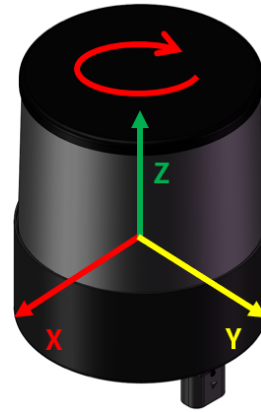

Figure 2. Coordinate system (isometric view)

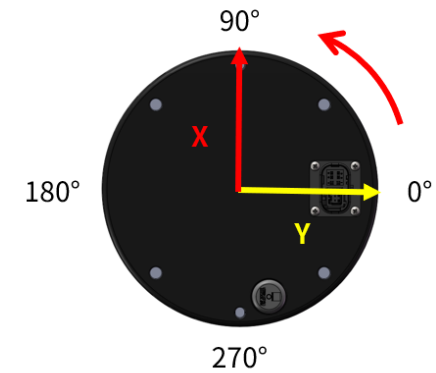

Figure 3. Lidar azimuthal position (bottom view)

i The figures above use Exterior 1 as an example; see [Section 2 Setup](#).

The lidar's coordinate system is illustrated in [Figure 2. Coordinate system \(isometric view\)](#).

- Z-axis is the axis of rotation.
- The origin's exact position is shown in [Section 1.5 Laser firing position](#) as a red dot. All measurements are relative to the origin.

The lidar's azimuthal position is defined in [Figure 3. Lidar azimuthal position \(bottom view\)](#).

- By default, the lidar rotates counterclockwise as viewed from below. To reverse the rotation direction, use either LidarUtilities or PTC commands.
- Y-axis corresponds to 0°.

1.4. Channel distribution

All channels are unevenly distributed, as illustrated in [Figure 4. Channel vertical distribution](#).

- Vertical resolution: See [Section 1.6 Specifications](#).
- The design values of each channel's angular position: See [Appendix A Channel distribution data](#).
- Channel number counts from 1, top to bottom.

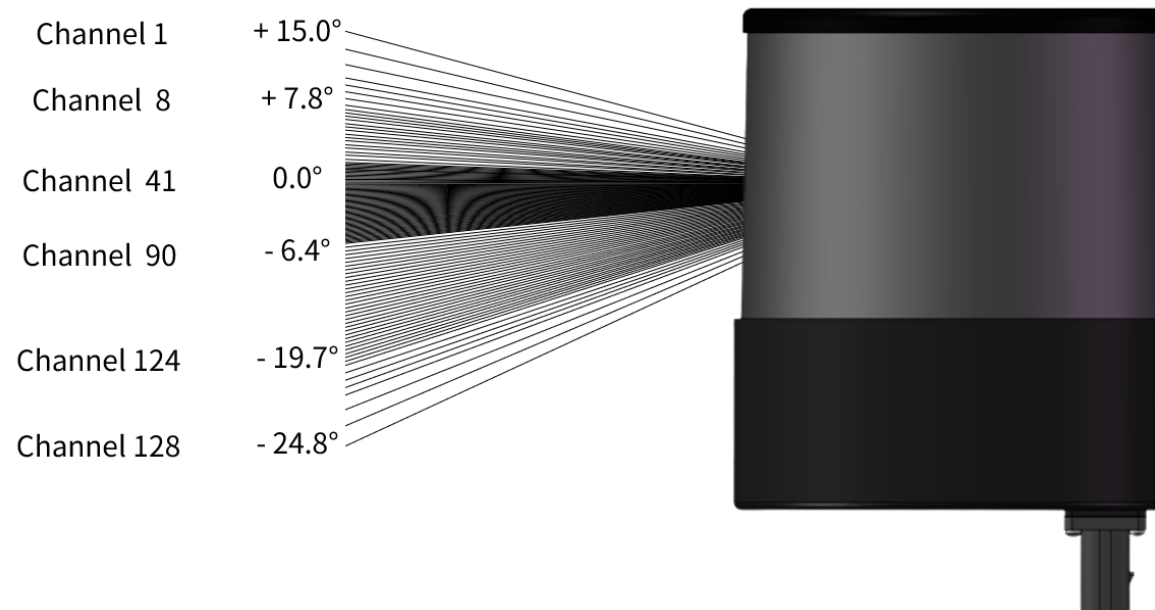

Figure 4. Channel vertical distribution



The figure above uses Exterior 1 as an example; see [Section 2 Setup](#).

1.5. Laser firing position

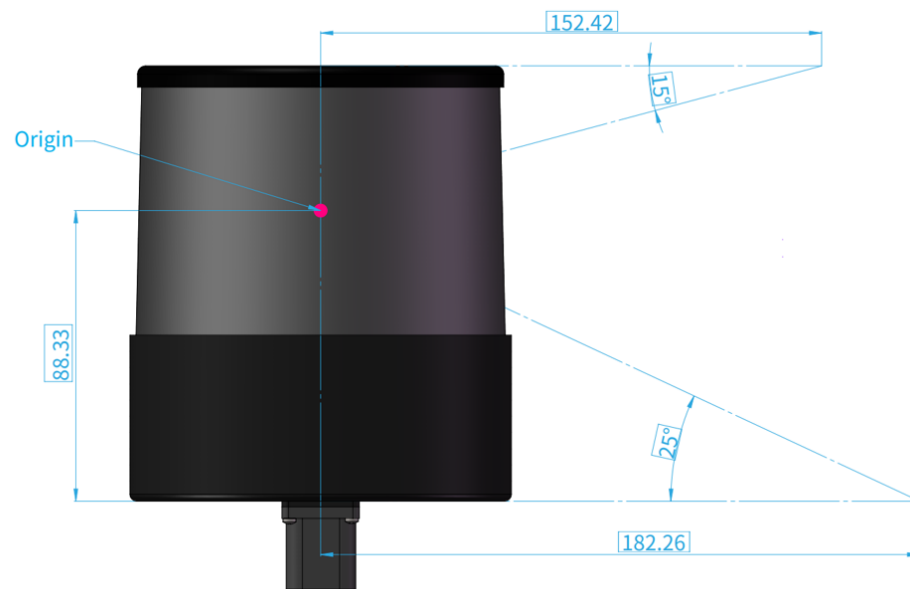

Figure 5. Front view (unit: mm)

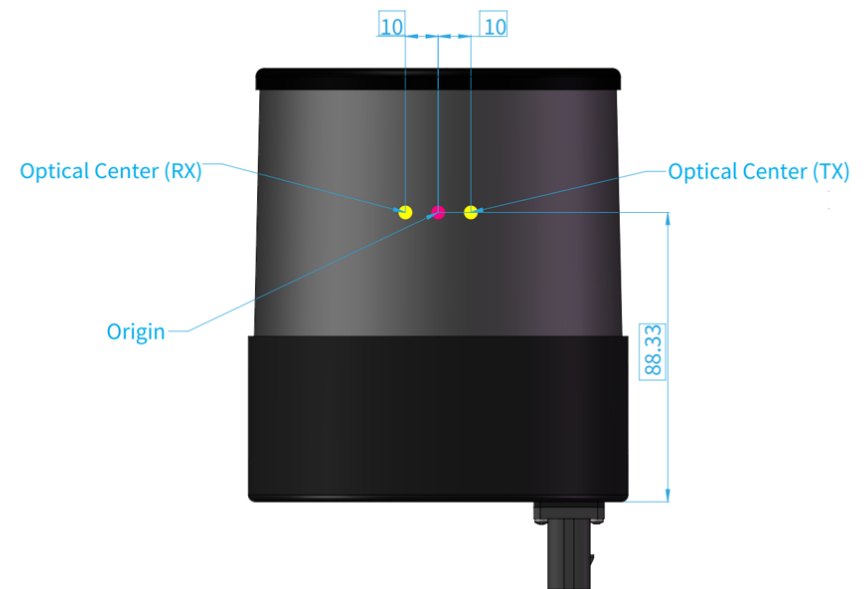

Figure 6. Side view (unit: mm)

i The figures above use Exterior 1 as an example; see [Section 2 Setup](#).

Each channel has an intrinsic angle offset, both horizontally and vertically. These angles are recorded in the angle correction file of this lidar, which is provided when shipping.

Angle correction file

In case you need to obtain this file again, please do one of the following:

- Send PTC command 0x05, as described in the TCP API Reference Manual.
- Export the file using PandarView 2 according to PandarView 2 user manual.
- Contact sales representatives or technical support.

1.6. Specifications

SENSOR

Scanning method	Mechanical rotation
Number of channels	128
Instrumented range	0.3 to 230 m
Ranging capability ①	1 to 200 m (at 10% reflectivity)
Ranging accuracy ②	±3 cm (3 to 200 m, typical)
Horizontal FOV	360°
Horizontal resolution	Configurable on-the-fly 0.1°/0.2° (10 Hz) 0.2°/0.4° (20 Hz)
Vertical FOV	40° (-25° to +15°)
Vertical resolution ③	0.125° (Channel 24 to 89) 0.36° (Channels 8 to 24, 89 to 121) 0.67° (Channels 4 to 8, 121 to 125) 1.2° to 1.72° (Channels 1 to 4, 125 to 128)
Frame rate	10 Hz, 20 Hz
Return mode	Single Return: Last/Strongest/First Dual Return: Last and Strongest, Last and First, First and Strongest

MECHANICAL/ELECTRICAL/OPERATIONAL

Wavelength	905 nm
Laser class	Class 1 Eye Safe

Ingress protection	IP6K7 & IP6K9K
Dimensions	Height: 132.3 mm Top/bottom: Φ 111.4/116.0 mm or Φ 111.4/118.0 mm
Rated voltage range	DC 9 to 32 V
Power consumption ^④	29 W
Operating temperature	-40°C to 75°C
Storage temperature	-40°C to 95°C
Weight	2.2 kg

DATA I/O

Data transmission	Automotive Ethernet, 1000BASE-T1, slave mode
Measurements	Distance, azimuth angle, and reflectivity
Valid data points	Single Return: 3 456 000 pts/sec (max) Dual Return: 6 912 000 pts/sec (max)
Point cloud data rate	Single Return: 130.61 Mbps (max) Dual Return: 261.22 Mbps (max)
Clock source	PTP (802.1AS Automotive, 802.1AS AUTOSAR)
PTP clock accuracy ^⑤	$\leq 1 \mu\text{s}$
PTP clock drift ^⑥	$\leq 1 \mu\text{s/s}$



Specifications are subject to change. Please refer to the latest version of this manual.

Notes to specifications

① Ranging capability (typical value)

- Measured under 100 klux ambient illuminance, probability of detection (PoD) > 70%.
- The ranging capability of each channel is listed in [Appendix A Channel distribution data](#).

② Ranging accuracy

- May vary with range, temperature, and target reflectivity.
- Typical value: Measured at 3/7/15/30 m, under room temperature, and with target reflectivities between 10% and 90%; met by 80% of all channels.

③ Horizontal resolution of each channel

- Shown in [Appendix A Channel distribution data](#).

④ Power consumption

- Test conditions: Room temperature, 12 V (lidar input voltage), and 600 RPM (spin rate).
- Not including accessories such as the connection box.
- The external power supply should be able to provide at least 35 W.

⑤⑥ PTP clock accuracy and clock drift (typical value)

Test condition: Room temperature

⑥ PTP clock drift

Defined as the drift at a constant temperature after the lidar (slave clock) loses connection to the PTP master.

2. Setup

Before operating the lidar, strip away the protective cover on the cover lens.



The information in this section may be different for customized models. The mechanical drawings and data exclusively provided for customized models shall prevail.

2.1. Mechanical installation

2.1.1. Exterior dimensions



OT128 is switching from "Exterior 1" to "Exterior 2". Please check the delivery notice.

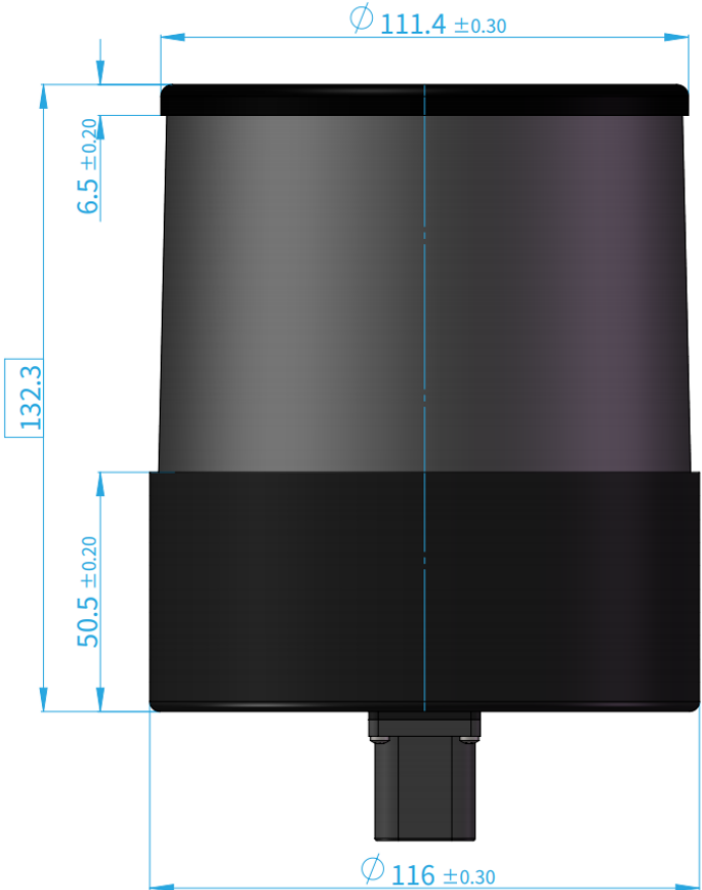

Figure 7. Front view (Exterior 1, unit: mm)

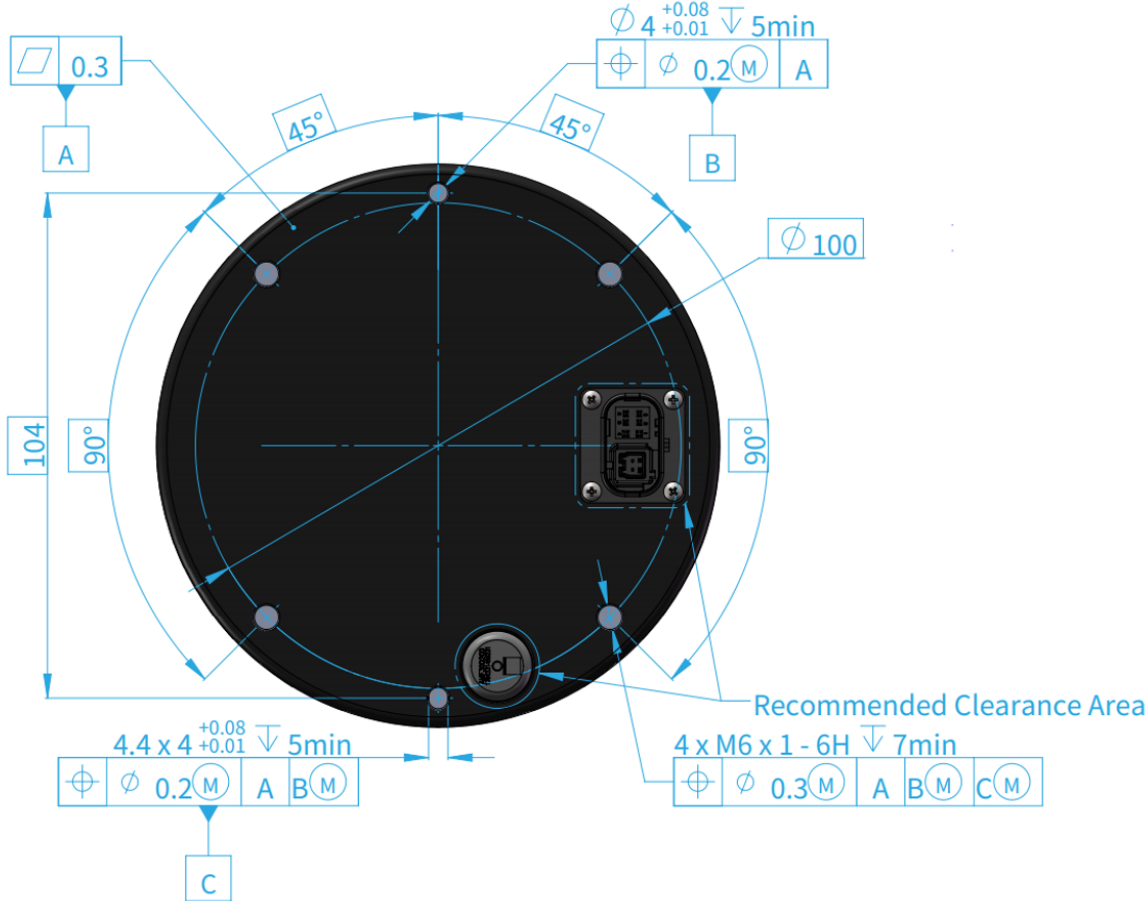

Figure 8. Bottom view (Exterior 1, unit: mm)

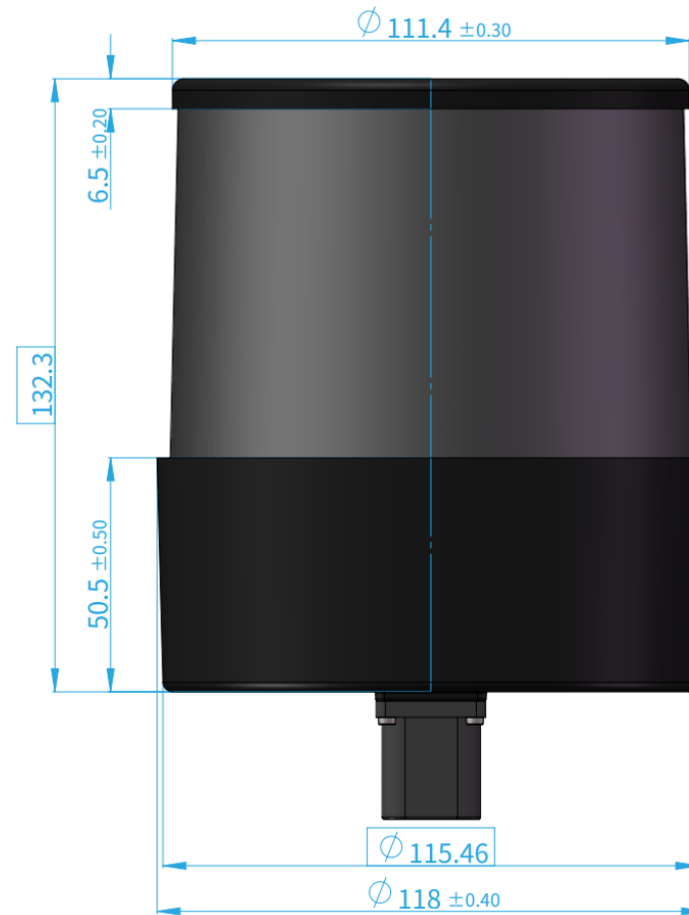

Figure 9. Front view (Exterior 2, unit: mm)

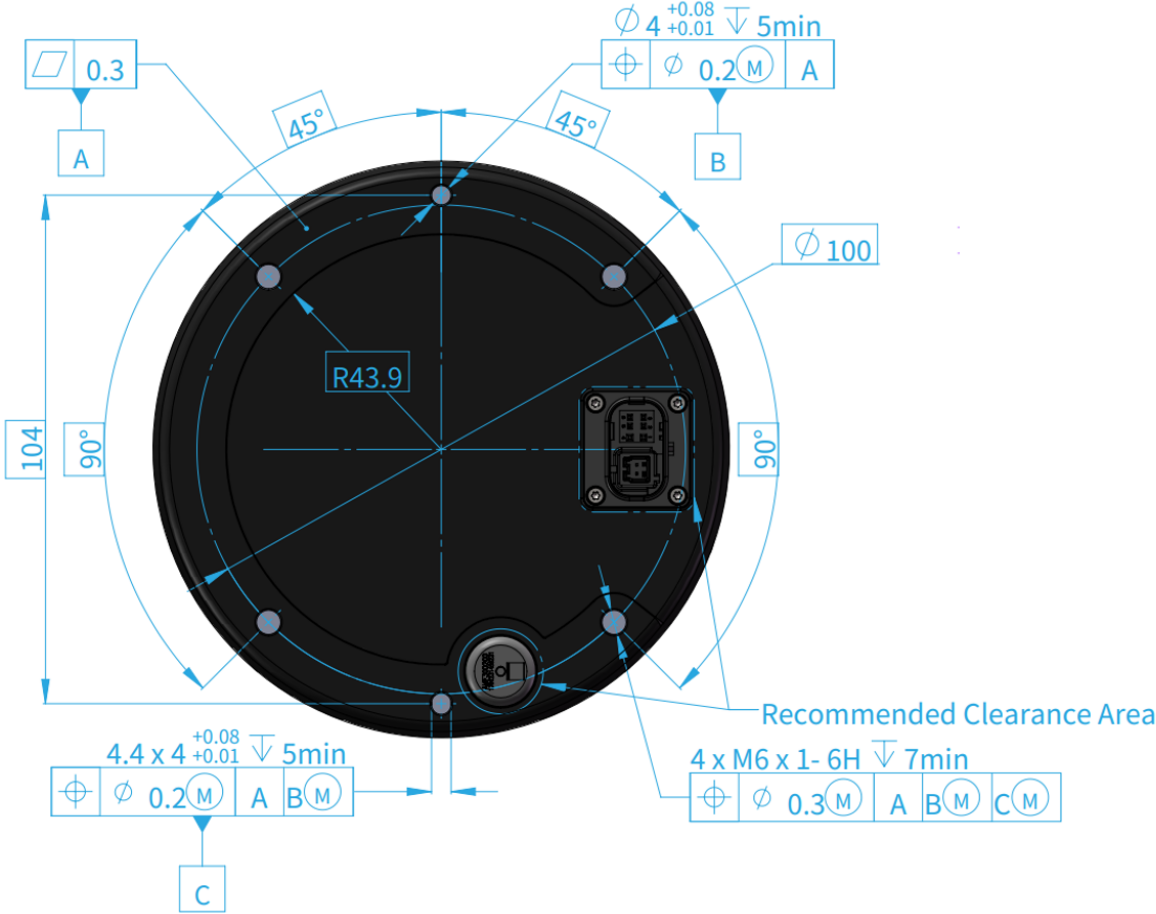

Figure 10. Bottom view (Exterior 2, unit: mm)

2.1.2. Recommended Installation

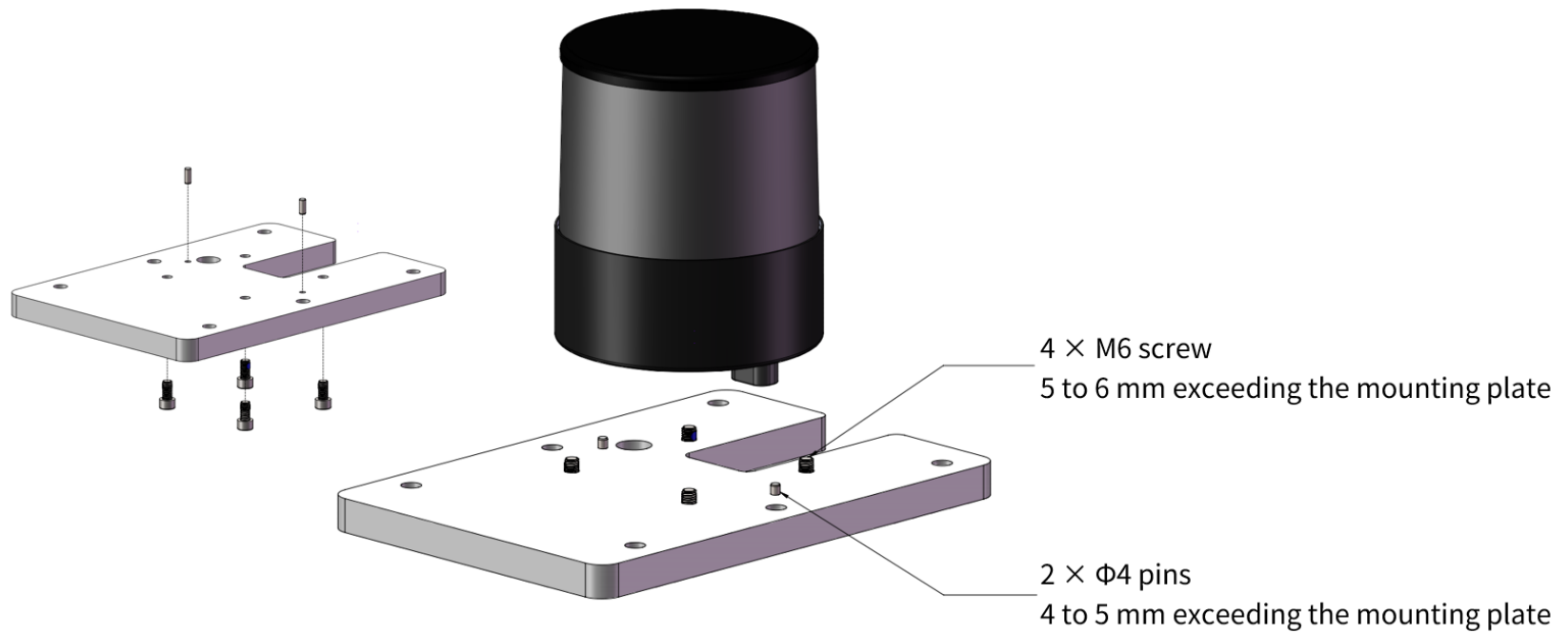

Figure 11. Recommended installation (Exterior 1)



The installation methods for Exterior 1 and 2 are the same. The figures above use Exterior 1 as an example; see [Section 2 Setup](#).

2.1.3. Notes on screw installation

Screw type

SEMS screws (with pre-attached flat washers and lock washers) are recommended. Property class should be at least 4.8.

Threadlocker

Before fastening a screw, apply 1 or 2 dots of threadlocker in the thread fit area. LOCTITE® 263 Threadlocker is recommended. To ensure curing it in place, wait for at least 12 hours before operating the lidar.

Screw torque

The base material of the threaded holes is aluminum alloy instead of steel. Refer to the following table for the appropriate screw torque.

Thread size	Recommended screw torque
M2	0.2 to 0.3 Nm
M3	0.5 to 0.6 Nm
M4	1 to 1.5 Nm
M5	2 to 2.5 Nm
M6	3 to 3.5 Nm

Thread service life

25 times

Each screwing counts as one time, so as each unscrewing.

2.2. Electrical interface

TE Connectivity part number: 2387351-1 (male socket, on the lidar)

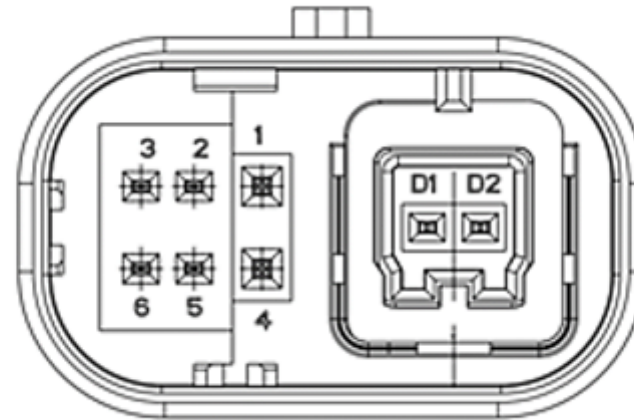

Figure 12. TE connector (male socket)

2.2.1. Pin description

No.	Signal	Voltage
1	VCC	9 to 32 V
2	Reserved	-
3	Index	0 to 3.3 V
4	GND	0 V
5	Reserved	-
6	Encoder	0 to 3.3 V

No.	Signal	Voltage
D2	MDI-P	-
D1	MDI-N	-

2.2.2. Connector use

Connection	<ol style="list-style-type: none"> 1. Turn off the power source. 2. Make sure the plug's red CPA is on the same side as the socket's locking nose. 3. Push the plug straight into the socket until you feel and hear a click. 4. Push the red CPA towards the socket until you feel and hear a click.
Disconnection	<ol style="list-style-type: none"> 1. Turn off the power source. 2. Pull the red CPA away from the socket until you feel and hear a click. 3. Depress the black locking latch; then pull the plug from the socket.

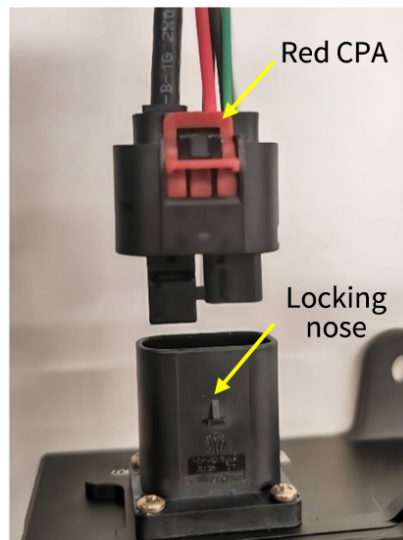

Figure 13. Connection

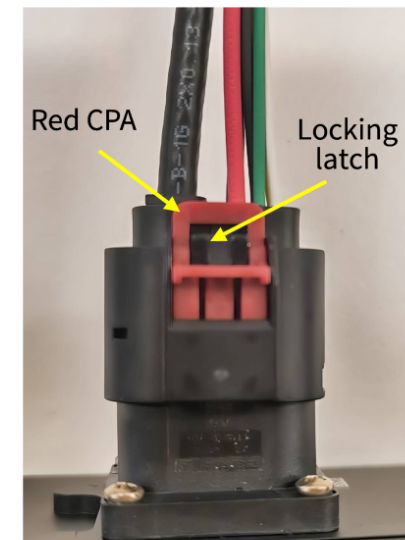

Figure 14. Disconnection



- Before connection, check the pins on the socket and the holes on the plug. In case of bent pins or damaged holes, stop using the connector and contact technical support.
- To prevent breakdowns, turn off the power source before connection and disconnection.

- Do NOT attempt to force open a connection by pulling on the cables or by twisting the connectors in any way. Doing so can loosen the connectors' shells, or even damage the contacts.
- If the connector's shell is accidentally pulled off, stop using the connector and contact Hesai technical support.
- Do NOT attempt to assemble the connector's shell and cable collet; do NOT connect a connector without its shell. Doing so may damage the lidar's circuits.
- For further troubleshooting, please contact Hesai's technical support or obtain work instructions from the connector manufacturer.
- The connector is designed to withstand at least 20 mating cycles; exceeding this number may increase the risk of connector damage.

2.2.3. Cables (Ethernet)

Outer diameter (OD) = 4.10 ± 0.20 mm

Minimum bend radius:

- Single: $5 \times \text{OD}$
- Multiple: $15 \times \text{OD}$

2.3. Connection box (optional)

Users may connect the lidar with or without a connection box. The connection box has a power port and a standard Ethernet port.

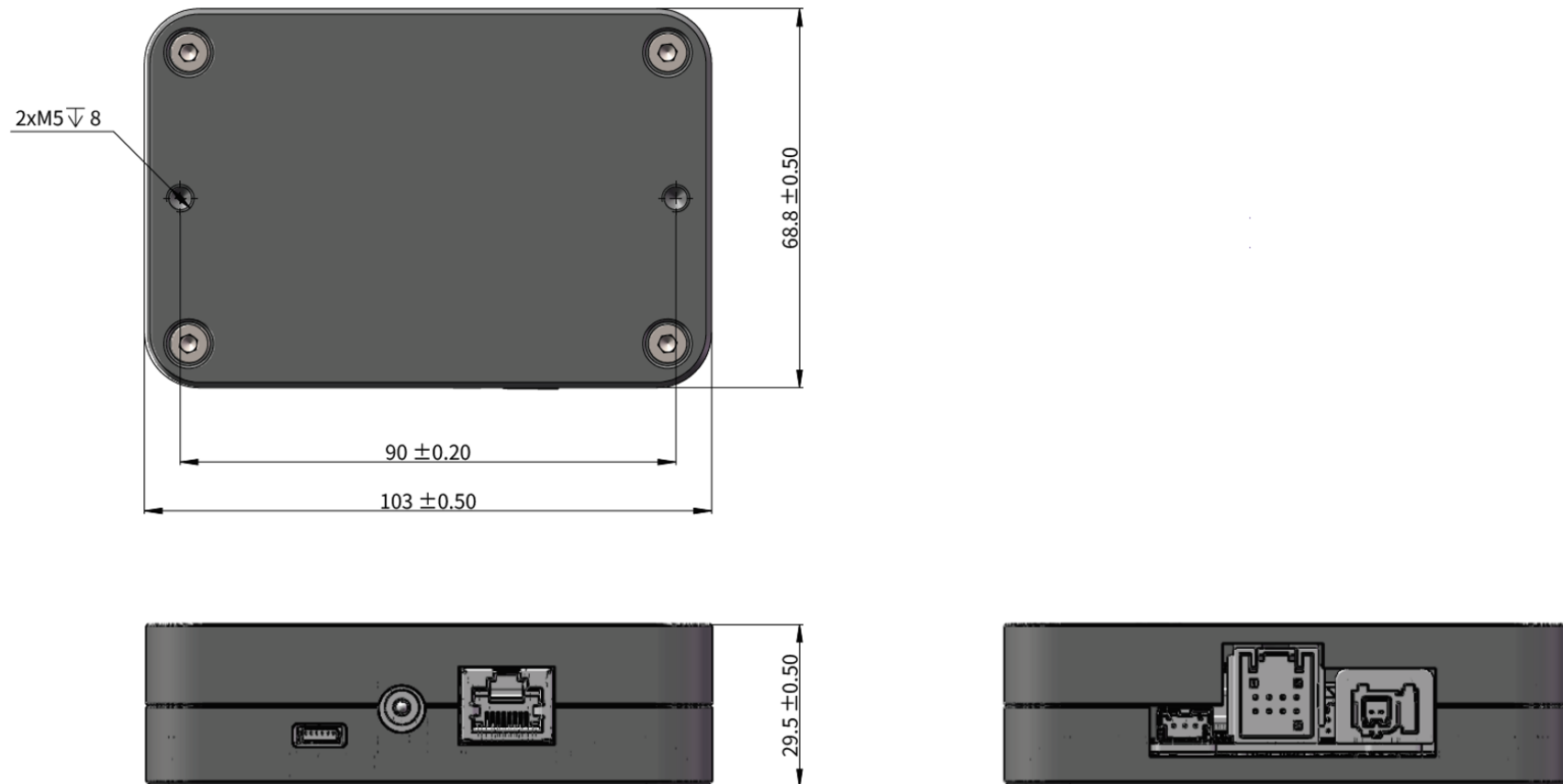

Figure 15. Connection box (unit: mm)

An additional cable is used for connecting the lidar (on the left) and the connection box (on the right), as shown below.

i Each lidar can only use one cable, for multiple cables cannot connect to each other.

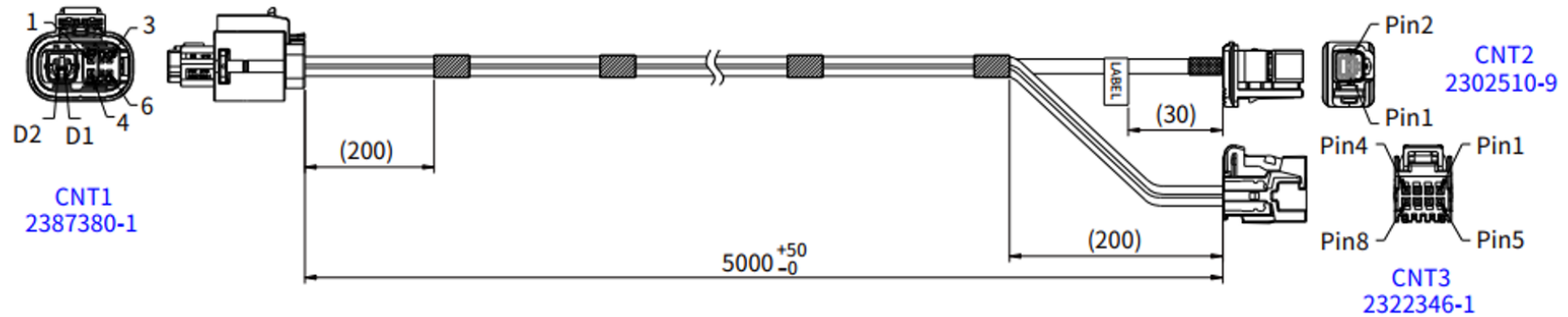

Figure 16. Cable between lidar and connection box

The wire colors and cross-sectional areas are shown below:

Pin No. on CNT1	Pin No. on CNT3	Signal	Wire color	Wire cross section
Pin 1	Pin 4	VCC	Red	0.75 mm ²
Pin 4	Pin 8	GND	Black	0.75 mm ²

Pin No. on CNT1	Pin No. on CNT2	Signal	Wire color
D2	Pin 1	MDI-P	White
D1	Pin 2	MDI-N	Green

2.3.1. Ports

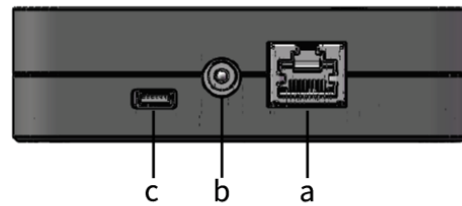

Figure 17. Connection box (front)

Port No.	Port name	Description
a	Standard Ethernet port	RJ45, 1000 Mbps Ethernet
b	Power port	Connects to a DC-005 DC power adapter.
c	Reserved port	Do NOT connect this port to external signals.

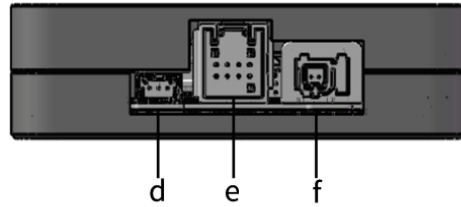

Figure 18. Connection box (back)

Port No.	Port name	Description	
d	Trigger port	Outputs external trigger signals for multi-sensor synchronization.	
		Connector (male plug)	Molex, LLC: 5023520300
		Recommended wire connector (female socket)	Molex, LLC: 5023510300
		Voltage	0 to 3.3 V
		Signal type	Pulse
		Max. output current	3 mA
e	Power Output port	See CNT 3 in Figure 16 . Cable between lidar and connection box.	
f	Automotive Ethernet port	See CNT2 in Figure 16 . Cable between lidar and connection box.	

Pin description for Port d

Pin No.	Direction	Signal	Description
1	Input	GND	Ground signal.
2	Output	Index	Outputs one pulse when the encoder angle is zero. Pulse width: 2.78 μ s @ 600 RPM, 1.39 μ s @ 1200 RPM

Pin No.	Direction	Signal	Description
3	Output	Encoder	Outputs one pulse when the lidar rotates 0.05°. Pulse width: 8.34 μ s @ 600 RPM, 4.17 μ s @ 1200 RPM

2.3.2. Connection

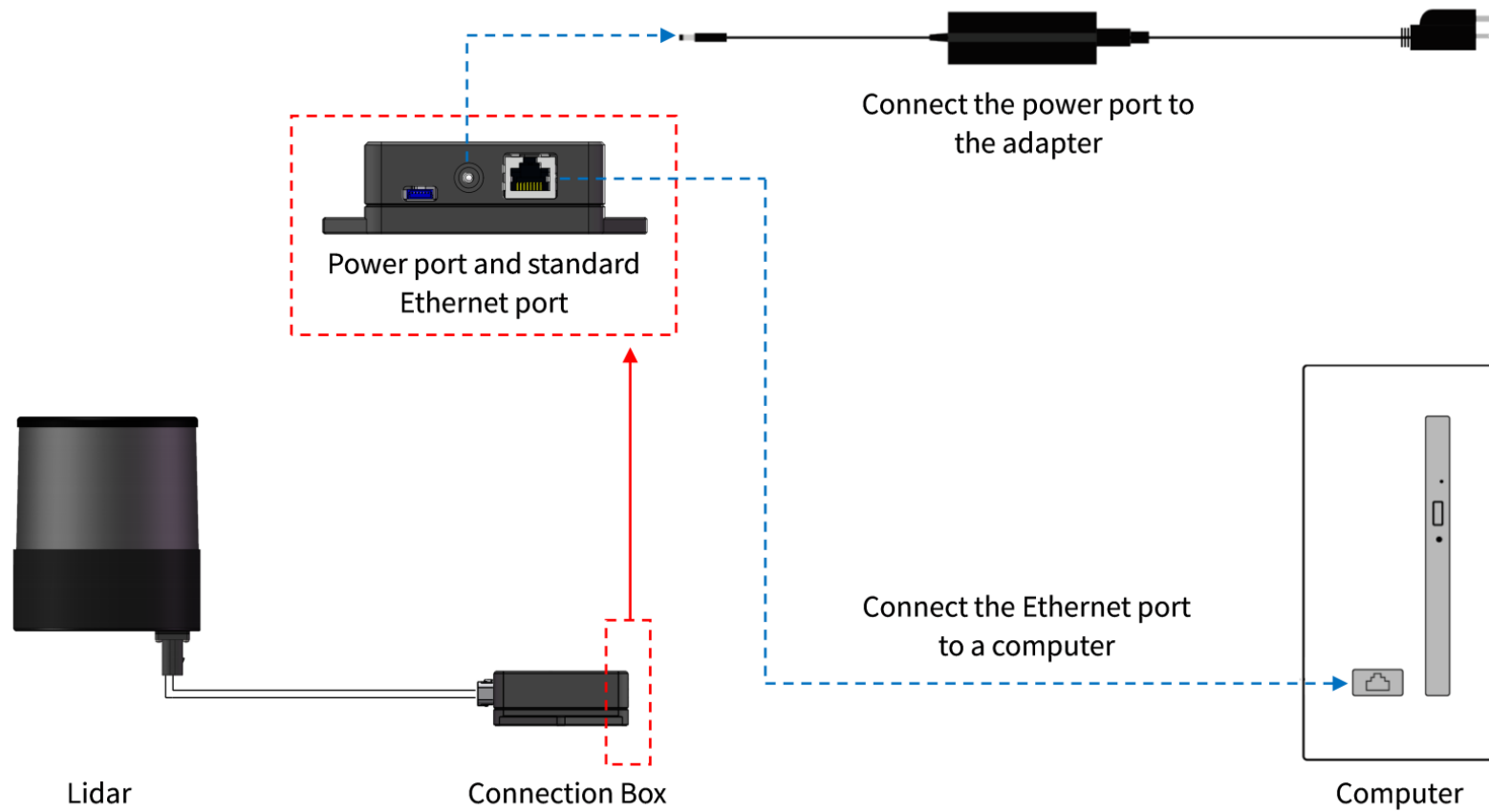

Figure 19. Connection with PTP (software simulation)

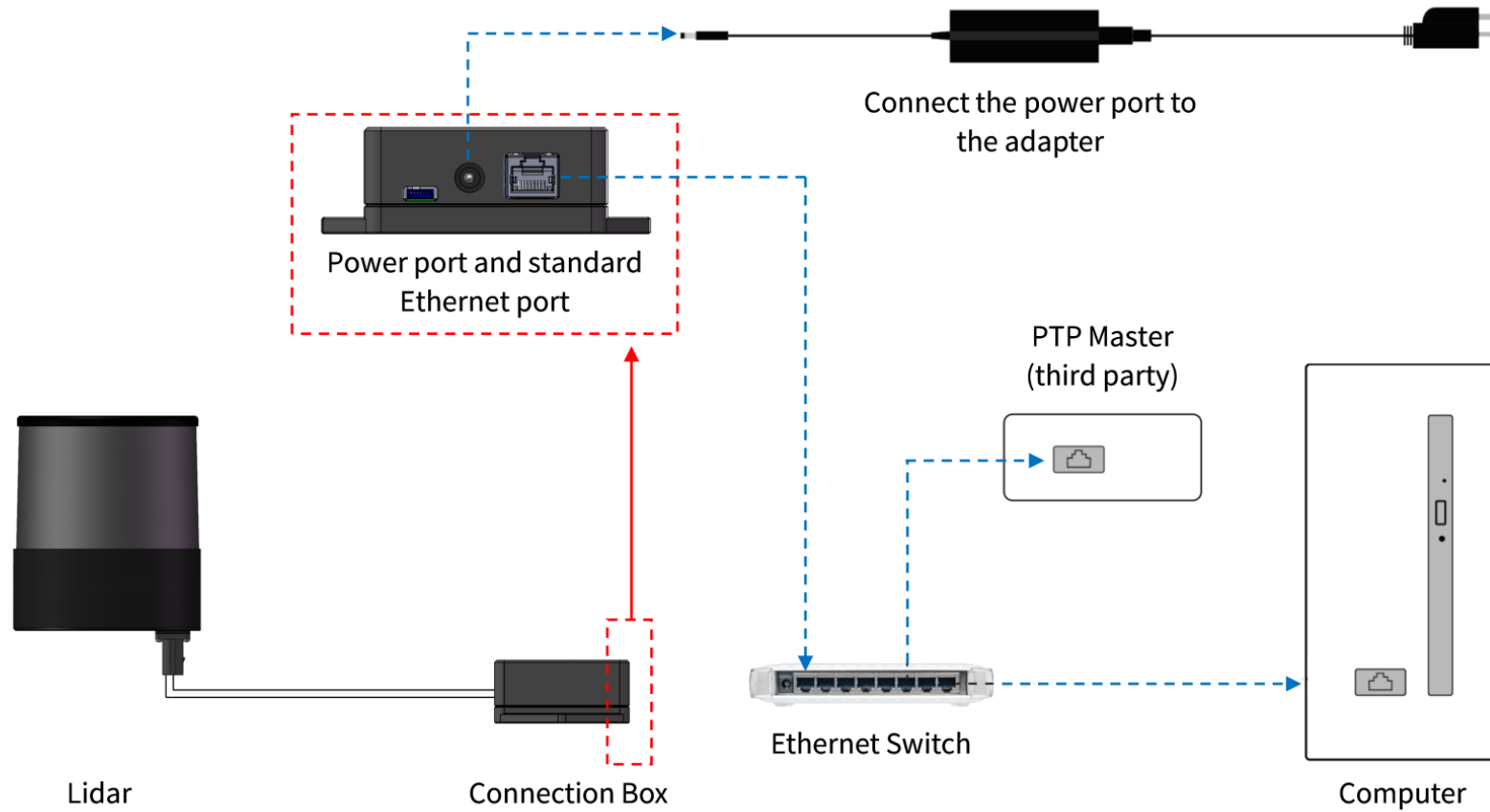

Figure 20. Connection with PTP (hardware device)

i The figures above use Exterior 1 as an example; see [Section 2 Setup](#).

2.4. Network settings on the receiving host

The lidar does not have a power switch. It starts transmitting data when both of these conditions are met:

- The lidar is connected to power.
- The lidar is connected to a host computer via Ethernet.

To analyze point cloud data, configure the network parameters of the host computer:

Network parameters	Value	Description
IP address	192.168.1.X	Given the lidar's IP address (192.168.1.201) and subnet mask (255.255.255.0), the following can be determined: <ul style="list-style-type: none">• Network address: 192.168.1.0• Gateway address: 192.168.1.1• Broadcast address: 192.168.1.255 Therefore, X can be selected from 2 to 200 and from 202 to 254.
Subnet mask	255.255.255.0	-
VLAN ID	Range: 1 to 4094	Required only when VLAN tagging is used. Make sure the host computer and the lidar use the same VLAN ID.

2.4.1. In Windows

1. "Control Panel" > "Network and Internet" > "Network and Sharing Center" > "Change Adapter Settings"
2. Right-click on the "Ethernet" or "Ethernet X" which shows Ethernet connection (with no red cross at the bottom left of the icon) > Select "Properties".

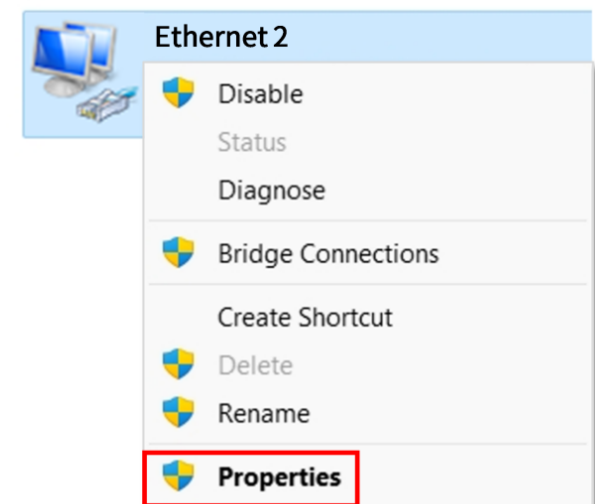
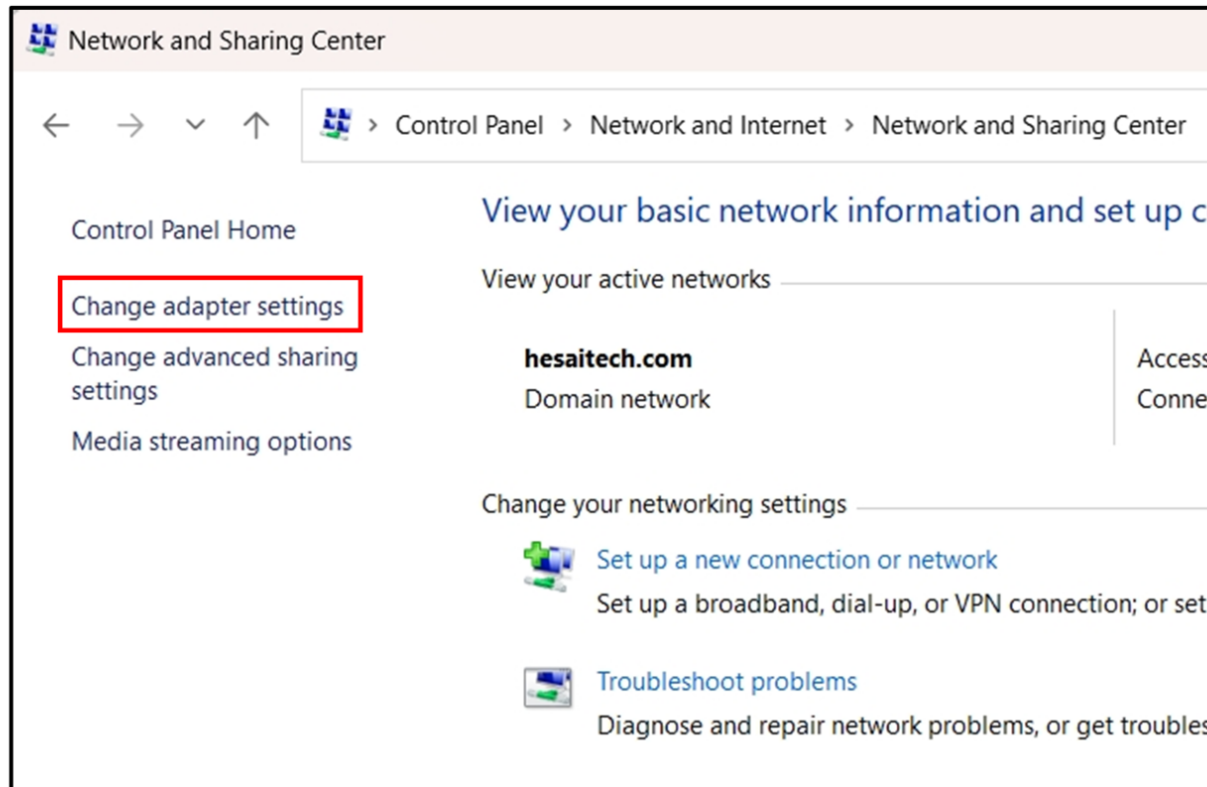

3. Double-click on "Internet Protocol Version 4 (TCP/IPv4)".
4. Select "Use the following IP addresses" > Input the host computers's IP address and subnet mask.

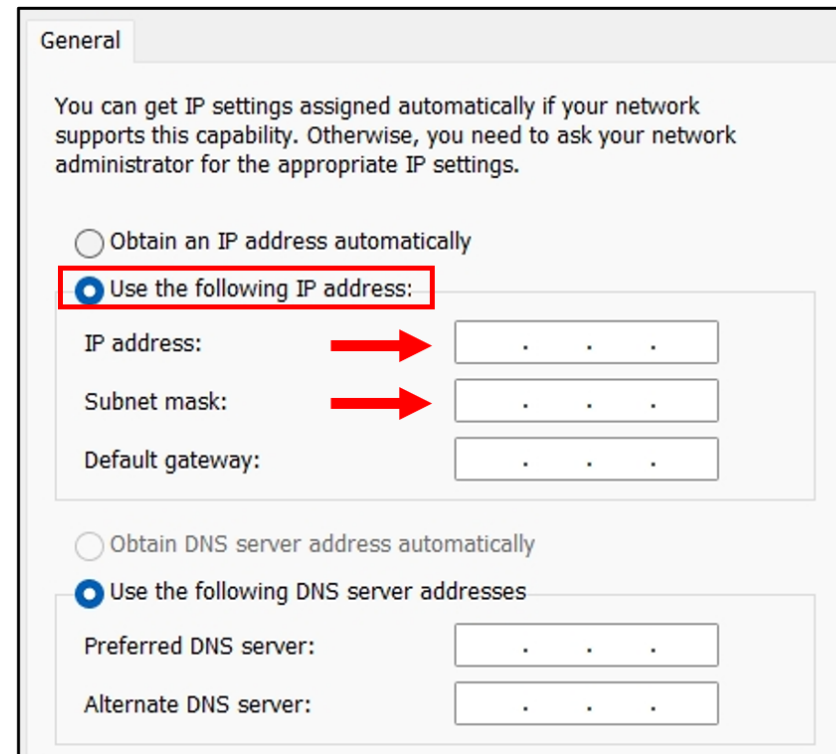
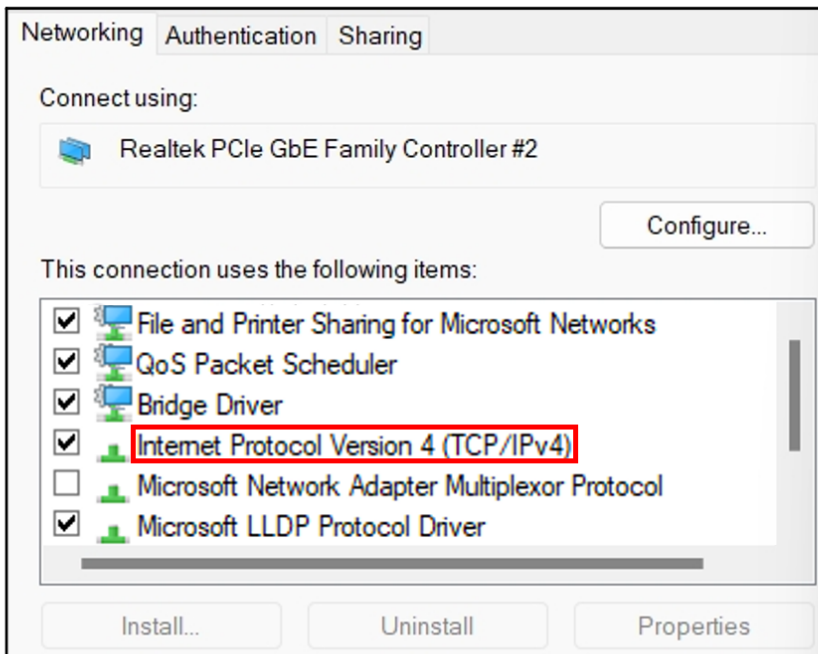

Ping command can be used to check the connection:

1. Press Windows key + R to open the "Run" box > Enter "cmd" > Click [**OK**].
2. Enter `ping ${source_ipv4}` > Press "Enter" > Check the output.

5. To enable VLAN tagging:

Click [**Configure**] > Under the "Advanced" tag, select "VLAN ID" from the "Property" list > Input a VLAN ID in the "Value" box > Click [**OK**].

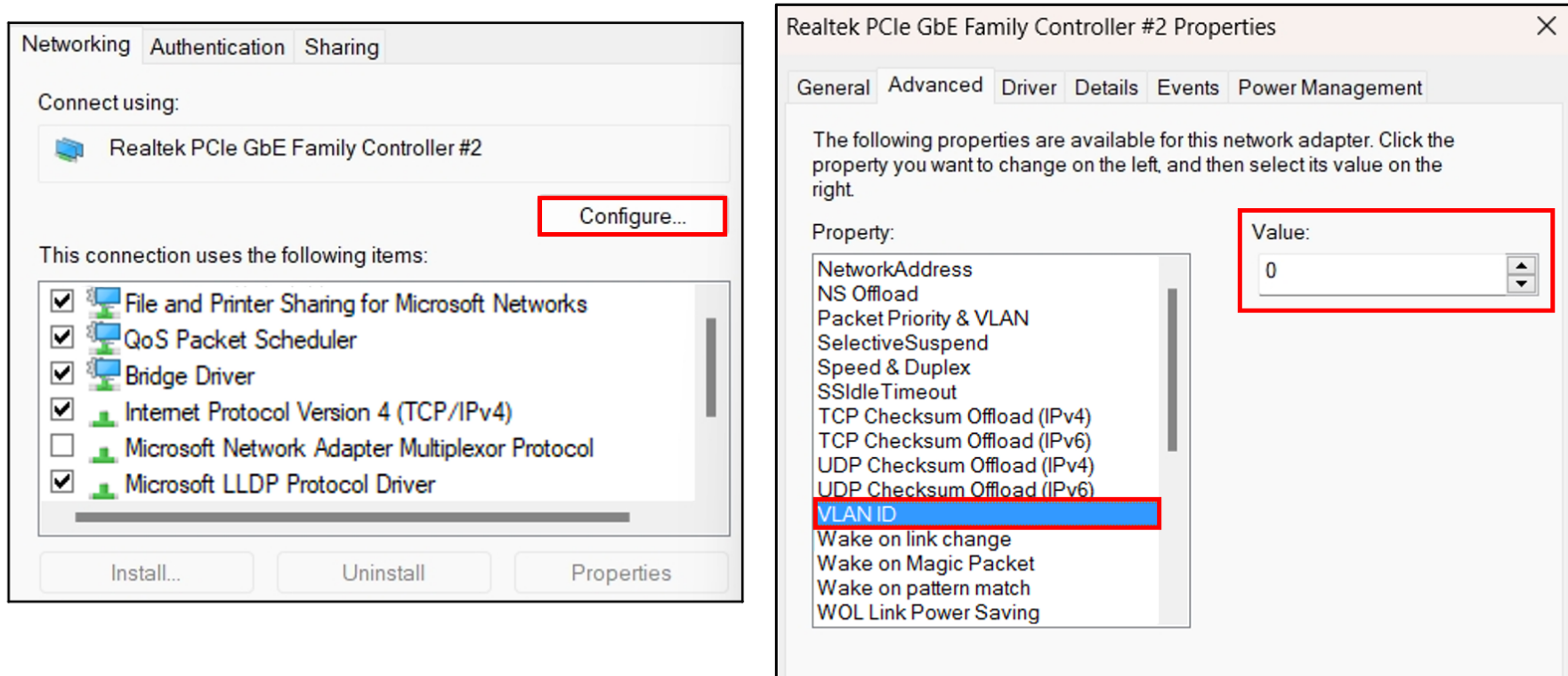

 If the "Property" list has no "VLAN ID", it is recommended to update the network adapter driver.

2.4.2. In Ubuntu

2.4.2.1. When not using VLAN

Run this command in the terminal:

```
sudo ifconfig ${interface_name} ${ip_addr}
```

- Replace `${interface_name}` with the host computer's network interface name.
- Replace `${ip_addr}` with the host computer's IP address.

2.4.2.2. When using a VLAN

Run this command in the terminal:

```
sudo ip link add link ${interface_name} name ${interface_name}.${vlan_id} type vlan id ${vlan_id}
sudo ip link set up ${interface_name}.${vlan_id}
sudo ip addr add ${ip_addr}/24 dev ${interface_name}.${vlan_id}
ip addr show ${interface_name}.${vlan_id}
```

- Replace `${interface_name}` with the host computer's network interface name.
- Replace `${vlan_id}` with the host computer's VLAN ID.
- Replace `${ip_addr}` with the host computer's IP address.

To check the host computer's network interface name:

Method 1

In the Settings--Network page, check the content in brackets after "Ethernet".



Method 2

Run `ifconfig` in the terminal.

```
> ifconfig
docker0: flags=4099<UP,BROADCAST,MULTICAST> mtu 1500
    inet [REDACTED] netmask [REDACTED] broadcast [REDACTED]
    ether [REDACTED] txqueuelen 0 (Ethernet)
    RX packets 0 bytes 0 (0.0 B)
    RX errors 0 dropped 0 overruns 0 frame 0
    TX packets 0 bytes 0 (0.0 B)
    TX errors 0 dropped 0 overruns 0 carrier 0 collisions 0

enp2s0f0: flags=4099<UP,BROADCAST,MULTICAST> mtu 1500
    ether [REDACTED] txqueuelen 1000 (Ethernet)
    RX packets 0 bytes 0 (0.0 B)
    RX errors 0 dropped 0 overruns 0 frame 0
    TX packets 0 bytes 0 (0.0 B)
    TX errors 0 dropped 0 overruns 0 carrier 0 collisions 0

enp5s0: flags=4099<UP,BROADCAST,MULTICAST> mtu 1500
    ether [REDACTED] txqueuelen 1000 (Ethernet)
    RX packets 267706980 bytes 300970909734 (300.9 GB)
    RX errors 0 dropped 0 overruns 0 frame 0
    TX packets 3184 bytes 590575 (590.5 KB)
    TX errors 0 dropped 0 overruns 0 carrier 0 collisions 0
```

2.5. Tools

Tool	Purpose	Where to find it
PandarView 2 (point cloud visualization software)	To record and display point cloud data.	Visit the Download page of Hesai's official website or contact Hesai technical support.
LidarUtilities, API	<p>To set parameters, check device info or upgrade firmware/software</p> <p> Network parameters:</p> <ul style="list-style-type: none"> • Default Source IPv4 address: 192.168.1.201 • Default PTC port: 9347 	Please contact Hesai technical support.
Software development kits (SDKs) and ROS drivers	To assist development.	Visit Hesai's official GitHub page: https://github.com/HesaiTechnology

3. Data structure

Unless otherwise specified, all the multi-byte fields are unsigned values in little-endian format.

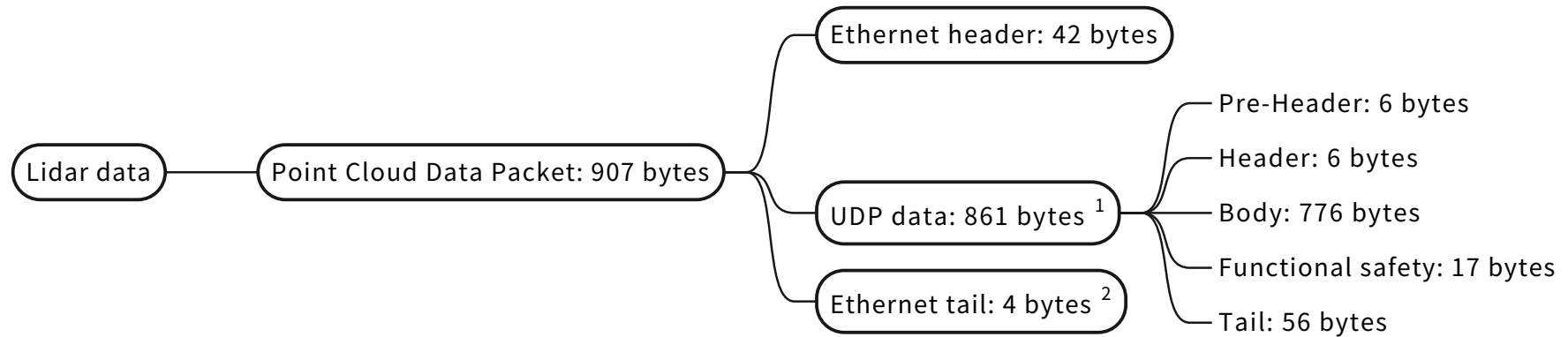

1. Discrete noise point flagging is OFF by default. When it is ON, the **UDP data** part will be 1117 bytes instead.

2. Network monitoring software (such as WireShark) usually does not display the **Ethernet tail** (4 bytes).

Figure 21. Data structure

3.1. Point Cloud Data Packet

Before receiving Point Cloud Data Packets, please perform [Section 2.4 Network settings on the receiving host](#).

3.1.1. Ethernet header

Point Cloud Data Packet: Ethernet header

Field	Byte(s)	Description
Ethernet II MAC	12	Destination MAC: xx:xx:xx:xx:xx:xx (FF:FF:FF:FF:FF:FF for broadcast) Source MAC: xx:xx:xx:xx:xx:xx
Ethernet Data Packet Type	2	0x08, 0x00
Internet Protocol	20	Protocol parameters
UDP Port Number	4	Source port (default: 10000) Destination port (default: 2368)
UDP Length	2	Eight bytes more than point cloud UDP data (see Figure 21. Data structure).
UDP Checksum	2	Checksum of the Ethernet header

3.1.2. Point cloud UDP data

3.1.2.1. Pre-Header

Field	Byte(s)	Description
0xEE	1	Start of Packet
0xFF	1	Start of Packet
Protocol Version Major	1	Main class of the point cloud UDP packet structure Current value: 0x01
Protocol Version Minor	1	Subclass of the point cloud UDP packet structure Current value: 0x04
Reserved	2	-

3.1.2.2. Header

Field	Byte(s)	Description																		
Channel Num	1	Number of laser channels Fixed: 0x80 (128)																		
Block Num	1	Number of block(s) per packet Fixed: 0x02 (2)																		
First Block Return	1	Reserved																		
Dis Unit	1	Fixed: 0x04 (4 mm)																		
Return Num	1	Maximum number of returns from each channel 0x02 (2)																		
Flags	1	<p>[7:6] and [4] are reserved. [5] and [3:0] indicate whether this data packet contains the following information (0b0111 by default):</p> <table border="1"> <thead> <tr> <th>Bit</th> <th colspan="2">Value</th> </tr> </thead> <tbody> <tr> <td>[5] Discrete noise points</td> <td>1 – YES</td> <td>0 – NO</td> </tr> <tr> <td>[3] Digital signature</td> <td>1 – YES</td> <td>0 – NO</td> </tr> <tr> <td>[2] Functional safety</td> <td>1 – YES</td> <td>0 – NO</td> </tr> <tr> <td>[1] IMU</td> <td>1 – YES</td> <td>0 – NO</td> </tr> <tr> <td>[0] UDP sequence</td> <td>1 – YES</td> <td>0 – NO</td> </tr> </tbody> </table>	Bit	Value		[5] Discrete noise points	1 – YES	0 – NO	[3] Digital signature	1 – YES	0 – NO	[2] Functional safety	1 – YES	0 – NO	[1] IMU	1 – YES	0 – NO	[0] UDP sequence	1 – YES	0 – NO
Bit	Value																			
[5] Discrete noise points	1 – YES	0 – NO																		
[3] Digital signature	1 – YES	0 – NO																		
[2] Functional safety	1 – YES	0 – NO																		
[1] IMU	1 – YES	0 – NO																		
[0] UDP sequence	1 – YES	0 – NO																		

3.1.2.3. Body

Field	Byte(s)	Description
Azimuth 1	2	For Block 1: Current reference angle of the azimuth Unit: 0.01°
Block 1	384 or 512	For Block 1: Measurements made by each channel (starting from Channel 1) Refer to Each block in the body .
Azimuth 2	2	For Block 2: Current reference angle of the azimuth
Block 2	384 or 512	For Block 2: Measurements made by each channel (starting from Channel 1)
CRC 1	4	CRC-32/MPEG-2 checksum of the Body

Return mode



The available Return mode(s) are listed in the **Return Mode** field in [Section 3.1.2.5 Tail](#).

In Single Return mode, the measurements of each round of firing are stored in one block.

In Dual Return mode, the measurements of each round of firing are stored in two adjacent blocks (see table below), and the **Azimuth** fields of these two blocks are the same.

Return mode	Block 1	Block 2	Note
Last and Strongest	Last return	Strongest return	If the last return is also the strongest, then Block 2 stores the second strongest return.
Last and First	Last return	First return	If there is only one return, then Block 1 and Block 2 store the same data.
First and Strongest	First return	Strongest return	If the first return is also the strongest, then Block 2 stores the second strongest return.

Each block in the body

Field	Byte(s)	Description												
Channel 1	3 or 4	Measurements of Channel 1 (Distance and Reflectivity)												
		<table border="1"> <thead> <tr> <th>Field</th> <th>Bytes</th> <th>Description</th> </tr> </thead> <tbody> <tr> <td>Distance</td> <td>2</td> <td>See Definition of the Distance field.</td> </tr> <tr> <td>Reflectivity</td> <td>1</td> <td> Range: 0 to 255 Default: linear mapping (Reflectivity = Reflectivity × 1%) Also refer to Appendix C Nonlinear reflectivity mapping.  The mapping between this field and target reflectivity can be selected using LidarUtilities or PTC commands. </td> </tr> <tr> <td>Weight Factor</td> <td>1</td> <td> This field is added only when bit[5] = 1 in the Flags field. Range: 0 to 255 The higher the value, the more likely this data point is a discrete noise point (e.g., rain, fog, dust, or exhaust fumes). </td> </tr> </tbody> </table>	Field	Bytes	Description	Distance	2	See Definition of the Distance field .	Reflectivity	1	Range: 0 to 255 Default: linear mapping (Reflectivity = Reflectivity × 1%) Also refer to Appendix C Nonlinear reflectivity mapping .  The mapping between this field and target reflectivity can be selected using LidarUtilities or PTC commands.	Weight Factor	1	This field is added only when bit[5] = 1 in the Flags field. Range: 0 to 255 The higher the value, the more likely this data point is a discrete noise point (e.g., rain, fog, dust, or exhaust fumes).
		Field	Bytes	Description										
		Distance	2	See Definition of the Distance field .										
Reflectivity	1	Range: 0 to 255 Default: linear mapping (Reflectivity = Reflectivity × 1%) Also refer to Appendix C Nonlinear reflectivity mapping .  The mapping between this field and target reflectivity can be selected using LidarUtilities or PTC commands.												
Weight Factor	1	This field is added only when bit[5] = 1 in the Flags field. Range: 0 to 255 The higher the value, the more likely this data point is a discrete noise point (e.g., rain, fog, dust, or exhaust fumes).												
Channel 2	3 or 4	Measurements of Channel 3												
...												
Channel 128	3 or 4	Measurements of Channel 128												

Definition of the Distance field (when Up-Close Blockage Detection is OFF)

Distance	Description
≥ 75	Object distance = Distance × Dis Unit ≥ 0.3 m Dis Unit: See Section 3.1.2.2 Header .
= 0	No valid point cloud output

Definition of the Distance field (when Up-Close Blockage Detection is ON)

Distance	Description
≥ 75	Object distance = Distance \times Dis Unit ≥ 0.3 m Dis Unit: See Section 3.1.2.2 Header .
= 0	No laser emission.
= 1	Return signal is received. Object distance: < 0.3 m (below the lower limit of the lidar measurement range) Therefore, no valid point cloud output.
= 1	Return signal is received. Object distance is between 0.3 m and 1.4 m (near-field measurement range), but the current channel is not a near-field-enabled channel (see Appendix A Channel distribution data). Therefore, no valid point cloud output.
= 3	Either no return signal is received, or the return signal is received but rejected. Thus no valid point cloud output. Common reasons for return signal rejection:  <ul style="list-style-type: none"> • The signal is generated by another lidar unit. • Object distance exceeds the upper limit of the lidar's measurement range. • Pulse intensity is below the threshold. • The signal is filtered out.

3.1.2.4. Functional safety



Field	Byte(s)	Description
FS Version	1	Version number of the functional safety module (currently 0x00)
Lidar State	1	[7:5] is the current Lidar State. d-0 (b-000) Initialization d-1 (b-001) Normal d-2 (b-010) Warning d-3 (b-011) Pre-Performance Degradation d-4 (b-100) Performance Degradation d-5 (b-101) Pre-Shutdown d-6 (b-110) Shutdown or Output Untrusted d-7 (b-111) Standby
Fault Code Type		[4:3] is the type of fault code in this data packet. b-01 Current fault b-10 Past fault (not supported in this version)
Rolling Counter		[2:0] indicates whether the fault reporting system gets stuck. Starting from 0, the rolling counter increments by 1 every 5 ms. Range: d-0 (b-000) to d-5 (b-101)
Total Fault Code Num	1	[7:4] is the total number of fault codes in the buffer queue.
Fault Code ID		[3:0] is the sequence number of the current fault code in the buffer queue, starting from 1.
Fault Code	2	The fault code sent by this data packet
Channel Health	8	Indicating the health status of each laser channel (emitter and receiver); see table below.

Field	Byte(s)	Description
CRC 2	4	CRC-32/MPEG-2 checksum of Functional Safety part (from the Lidar State field to the Channel1 Heath field)

 The Lidar States and fault codes are described in the Safety Manual. Please contact Hesai technical support for more information.

3.1.2.5. Tail

Field	Byte(s)	Description
Reserved	9	-
Azimuth State	2	[15:14] is the azimuth state of Block 1, and [13:12] the azimuth state of Block 2. <ul style="list-style-type: none"> Used for looking up the laser firing time; see Section B.4 Laser firing time of each channel. Range: 0 to 1 (Standard mode), 0 to 3 (High Resolution mode) [11:0] is reserved.
Operational State	1	0 — High Resolution 1 — Shutdown 2 — Standard
Return Mode	1	0x33 — First 0x37 — Strongest 0x38 — Last 0x39 — Last and Strongest 0x3B — Last and First 0x3C — First and Strongest
Motor Speed	2	Unit: RPM  Spin rate of the motor (RPM) = frame rate (Hz) × 60

Field	Byte(s)	Description														
Date & Time	6	The whole second part of the Coordinated Universal Time (UTC) of this data packet.														
		<table border="1"> <thead> <tr> <th>Each byte</th> <th>Range (decimal)</th> </tr> </thead> <tbody> <tr> <td>Year (current year minus 1900)</td> <td>≥ 70</td> </tr> <tr> <td>Month</td> <td>1 to 12</td> </tr> <tr> <td>Day</td> <td>1 to 31</td> </tr> <tr> <td>Hour</td> <td>0 to 23</td> </tr> <tr> <td>Minute</td> <td>0 to 59</td> </tr> <tr> <td>Second</td> <td>0 to 59</td> </tr> </tbody> </table>	Each byte	Range (decimal)	Year (current year minus 1900)	≥ 70	Month	1 to 12	Day	1 to 31	Hour	0 to 23	Minute	0 to 59	Second	0 to 59
		Each byte	Range (decimal)													
		Year (current year minus 1900)	≥ 70													
		Month	1 to 12													
		Day	1 to 31													
		Hour	0 to 23													
		Minute	0 to 59													
Second	0 to 59															
 The absolute time of Point Cloud Data Packets is defined in Appendix B Absolute time of point cloud data .																
Timestamp	4	The microsecond part of the Coordinated Universal Time (UTC) of this data packet. Unit: μs Range: 0 to 999 999 μs														
 The absolute time of Point Cloud Data Packets is defined in Appendix B Absolute time of point cloud data .																
Factory Information	1	Fixed: 0x42														
UDP Sequence	4	Sequence number of this data packet Range: 0 to 0xFF FF FF FF														
IMU Temperature	2	Temperature provided by the IMU (inertial measurement unit) Data type: signed integer Unit: 0.01°C														

Field	Byte(s)	Description								
IMU Acceleration Unit	2	<p>Conversion factor of acceleration Data type: unsigned integer Current value: 244 (0x00F4)</p> <p>Unit of acceleration: $0.001mg \times 244 = 0.244mg$ (g : standard gravity)</p>								
IMU Angular Velocity Unit	2	<p>Conversion factor of angular velocity Data type: unsigned integer Current value: 1750 (0x06D6)</p> <p>Unit of angular velocity: $0.01 \text{ mdps} \times 1750 = 17.5 \text{ mdps}$ (millidegree per second)</p>								
IMU Timestamp	4	<p>Timestamp of the IMU data Reset to 0 after powering on the lidar or after an overflow. Unit: 25 μs Range: 0 to approx. 29.83 hours</p>								
IMU X Axis Acceleration	2	<p>Acceleration of the X-axis, measured by the IMU. Data type: signed integer</p> <table border="1"> <tbody> <tr> <td>Data type</td> <td>Signed integer</td> </tr> <tr> <td>Measurement range</td> <td>$\pm 8g$</td> </tr> <tr> <td>Unit of acceleration</td> <td>See the IMU Acceleration Unit field; currently 0.244mg.</td> </tr> <tr> <td>Example</td> <td>When this field is 5, X-axis acceleration = $5 \times 0.244mg = 1.22mg$.</td> </tr> </tbody> </table>	Data type	Signed integer	Measurement range	$\pm 8g$	Unit of acceleration	See the IMU Acceleration Unit field; currently 0.244mg.	Example	When this field is 5, X-axis acceleration = $5 \times 0.244mg = 1.22mg$.
Data type	Signed integer									
Measurement range	$\pm 8g$									
Unit of acceleration	See the IMU Acceleration Unit field; currently 0.244mg.									
Example	When this field is 5, X-axis acceleration = $5 \times 0.244mg = 1.22mg$.									
IMU Y Axis Acceleration	2	Acceleration of the Y-axis								
IMU Z Axis Acceleration	2	Acceleration of the Z-axis								

Field	Byte(s)	Description	
IMU X Axis Angular Velocity	2	Angular velocity of the X-axis, measured by the IMU.	
		Data type	Signed integer
		Measurement range	± 500 dps
		Unit of angular velocity	See the IMU Angular Velocity Unit field; currently 17.5 mdps.
		Example	When this field is 5, X-axis angular velocity = 5×17.5 mdps = 87.5 mdps.
IMU Y Axis Angular Velocity	2	Angular velocity of the Y-axis	
IMU Z Axis Angular Velocity	2	Angular velocity of the Z-axis	
CRC 3	4	CRC-32/MPEG-2 checksum of the Tail	

3.1.3. Ethernet tail

Field	Byte(s)	Description
FCS	4	Frame check sequence

3.1.4. Point cloud data analysis method

Take **Channel 5** in **Block 2** as an example.

3.1.4.1. Analyze the vertical angle of a data point

The designed vertical angle of **Channel 5** is 9.836° , according to [Appendix A Channel distribution data](#).



- The accurate vertical angles are recorded in the angle correction file of this lidar; see [Section 1.4 Channel distribution](#).
- 0° is the horizontal direction.
- The upward direction is defined as positive; see [Figure 4. Channel vertical distribution](#).

3.1.4.2. Analyze the horizontal angle of a data point

- i** The Y-axis of the lidar coordinate system is 0°. The counterclockwise direction (as viewed from below) is defined as positive; see [Figure 3. Lidar azimuthal position \(bottom view\)](#).

$$\text{Horizontal angle} = \textcircled{1} + \textcircled{2}$$

- ① Angular position at the start time (see [Section B.3 Start time of each block](#)) of the current block
- ② Firing time angular offset of the current firing channel

$$\textcircled{1} = \textcircled{3} + \textcircled{4}$$

- ③ Current reference azimuth of this block
Can be read from the **Azimuth** field of **Block 2**. See [Section 3.1.2.3 Body](#).
- ④ Horizontal angle offset of the current firing channel
The offset of **Channel 5** is 0.148°, according to [Appendix A Channel distribution data](#).

- i** The accurate horizontal angle offsets are recorded in the angle correction file of this lidar; see [Section 1.4 Channel distribution](#).

$$\textcircled{2} = \textcircled{5} \times \textcircled{6}$$

- ⑤ Firing time offset of the current firing channel
See [Section B.4 Laser firing time of each channel](#).
- ⑥ Spin rate of the motor
See the **Motor Speed** field in [Section 3.1.2.5 Tail](#). The unit should be converted to °/s.

3.1.4.3. Analyze the distance of a data point

See the **Distance** field of **Block 2: Channel 5** in [Section 3.1.2.3 Body](#).

3.1.4.4. Draw the data point in a spherical or rectangular coordinate system

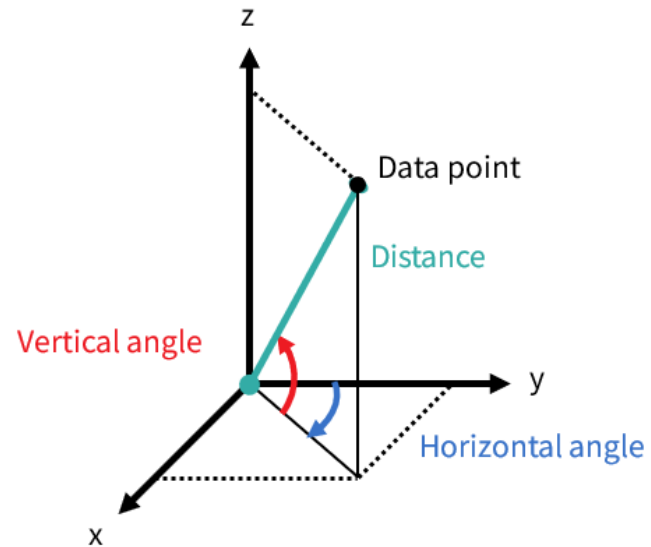

3.1.4.5. Obtain the real-time point cloud data by analyzing and drawing every data point in each frame

4. Parameter interfaces

All the parameters in this section can be accessed using API; some of the parameters are also shown in lu.

4.1. Network connection

4.1.1. Source

Source IPv4 Address

Option(s)	Description
Default: 192.168.1.201	Applies to both UDP and PTC ports.

Source IPv4 Subnet Mask

Option(s)	Description
Default: 255.255.255.0	Applies to both UDP and PTC ports.

Source IPv4 Gateway

Option(s)	Description
Default: 192.168.1.1	Applies to both UDP and PTC ports.

Ethernet Communication Mode

Option(s)	Description
Slave (default) Master	<p data-bbox="645 277 1379 309">Role of the lidar in automotive Ethernet communication.</p> <p data-bbox="645 352 1742 384">When the lidar is in Slave mode (default), the receiving host shall be in Master mode.</p> <ul data-bbox="741 421 2033 576" style="list-style-type: none"> <li data-bbox="741 421 2033 496">• Connection cannot be made if the lidar and the receiving host are both Masters or both Slaves. To minimize such risks, please take special care when changing this setting. <li data-bbox="645 464 2033 576">  • The connection box in Section 2.3 Connection box (optional) can be used only when the lidar is in Slave mode. <p data-bbox="645 632 1122 663">To change the lidar to Master mode:</p> <ol data-bbox="645 691 1659 807" style="list-style-type: none"> <li data-bbox="645 691 1133 722">1. Connect the lidar to a Master host. <li data-bbox="645 730 1659 762">2. Change the lidar from Slave mode to Master mode. Connection will be lost. <li data-bbox="645 770 1532 802">3. Connect the lidar to a Slave host and the connection will resume.

VLAN

Option(s)	Description
Default: OFF VLAN ID: 1 to 4094	<p>VLAN tagging</p> <p>To enable VLAN tagging, use the same VLAN ID on both the lidar and the receiving host.</p> <ul style="list-style-type: none"> • Connection cannot be made if the lidar and the receiving host use different VLAN IDs. • To minimize such risks, the VLAN ID in LidarUtilities is zero (an invalid value) by default. When checking the checkbox, users will be alerted to input a valid VLAN ID; when unchecking the checkbox, the VLAN ID will default to zero. <p>• Once configured, VLAN ID will not change during firmware upgrades.</p> <p>• When VLAN is enabled, PTP connection will be lost; when VLAN is disabled, PTP connection will automatically recover.</p>

4.1.2. Destination**Destination IPv4 Address**

Option(s)	Description	
Any except 0.0.0.0, 127.0.0.1, and the lidar's IPv4 address Default: 255.255.255.255	Communication mode	Destination IP
	Broadcast (default)	255.255.255.255
	Multicast	User-defined
	Unicast	Same as the PC's IPv4 address

Destination Point Cloud UDP Port

Option(s)	Description
Default: 2368	Destination port for Point Cloud Data Packets

4.2. Functional settings

 Cybersecurity functions are described in the Security Manual. Please contact Hesai technical support for more information.

Azimuth FOV

Option(s)	Description						
Default: 360° for all channels	<p>The lidar outputs valid data only within the specified azimuth FOV range(s).</p> <table border="1"> <thead> <tr> <th>Configuration mode</th> <th>Description</th> </tr> </thead> <tbody> <tr> <td>For all channels (default)</td> <td>Specify a continuous angle range [Start Angle, End Angle] that applies to all channels.</td> </tr> <tr> <td>Multi-section FOV</td> <td>Specify multiple (≤ 5) continuous angle ranges that apply to all channels.</td> </tr> </tbody> </table> <ul style="list-style-type: none"> The angles in degrees are accurate to the first decimal place. If the Start Angle is larger than the End Angle, then the actual range is the union of [Start Angle, 360°) and [0°, End Angle). For instance, when the angle range is set to be [270°, 90°), the actual azimuth FOV is [270°, 360°) \cup [0°, 90°). 	Configuration mode	Description	For all channels (default)	Specify a continuous angle range [Start Angle, End Angle] that applies to all channels.	Multi-section FOV	Specify multiple (≤ 5) continuous angle ranges that apply to all channels.
Configuration mode	Description						
For all channels (default)	Specify a continuous angle range [Start Angle, End Angle] that applies to all channels.						
Multi-section FOV	Specify multiple (≤ 5) continuous angle ranges that apply to all channels.						

Blooming Filtering

Option(s)	Description									
ON (default) OFF	<p data-bbox="645 277 1261 309">To reduce blooming points in point cloud data.</p> <p data-bbox="645 347 2040 419">  Definition of blooming points: the dilated false positives outside the actual shape of a retroreflector, as if the retroreflector has bloomed in size. </p> <p data-bbox="725 464 1827 496">The intensity of blooming points are lower than that of the points on the retroreflector.</p> <p data-bbox="645 549 1312 580">When ON, filter out the suspected blooming points.</p> <p data-bbox="645 624 1137 655">When OFF, use the following strategy:</p> <table border="1" data-bbox="645 676 2074 895"> <thead> <tr> <th data-bbox="656 683 1003 740">Type of data points</th> <th data-bbox="1003 683 1361 740">Action</th> <th data-bbox="1361 683 2065 740">Reflectivity field in Point Cloud Data Packets</th> </tr> </thead> <tbody> <tr> <td data-bbox="656 740 1003 842">Suspected blooming points</td> <td data-bbox="1003 740 1361 842">Kept (instead of filtered out)</td> <td data-bbox="1361 740 2065 842">Set to zero</td> </tr> <tr> <td data-bbox="656 842 1003 895">Other points</td> <td data-bbox="1003 842 1361 895">Kept</td> <td data-bbox="1361 842 2065 895">Increments by 1 (to avoid being zero)</td> </tr> </tbody> </table>	Type of data points	Action	Reflectivity field in Point Cloud Data Packets	Suspected blooming points	Kept (instead of filtered out)	Set to zero	Other points	Kept	Increments by 1 (to avoid being zero)
Type of data points	Action	Reflectivity field in Point Cloud Data Packets								
Suspected blooming points	Kept (instead of filtered out)	Set to zero								
Other points	Kept	Increments by 1 (to avoid being zero)								

Horizontal Resolution Mode

Option(s)	Description		
Standard High Resolution (default)	The current horizontal resolution mode is shown in Point Cloud Data Packets; see the Operational State field in Section 3.1.2.5 Tail .		
	Horizontal resolution mode	Frame rate	Horizontal resolution
	Standard	10 Hz	0.2° for all channels
		20 Hz	0.4° for all channels
	High Resolution	10 Hz	0.1° for the 64 high-res channels (Channels 25 to 88) 0.2° for the other channels
		20 Hz	0.2° for the 64 high-res channels (Channels 25 to 88) 0.4° for the other channels

Reflectivity Mapping

Option(s)	Description	
Linear Mapping (default) Nonlinear Mapping #1/#2	Linear Mapping	The Reflectivity field in Point Cloud Data Packets linearly represents target reflectivity (0 to 255%).
	Nonlinear Mapping	The mapping between the Reflectivity field and target reflectivity is nonlinear. This increases the contrast in low-reflectivity areas (see Appendix C Nonlinear reflectivity mapping).

Return Mode

Option(s)	Description
Single Return: <ul style="list-style-type: none"> • Last • Strongest • First Dual Return: <ul style="list-style-type: none"> • Last and Strongest (default) • Last and First • First and Strongest 	The current return mode is shown in Point Cloud Data Packets; see the Return Mode field in Section 3.1.2.5 Tail .

Rotation Direction

Option(s)	Description
Clockwise (default) Counterclockwise	Direction of motor rotation (in the lidar's top view)

Spin Rate

Option(s)	Description
600 RPM (default) 1200 RPM	Spin rate of the motor The current spin rate is shown in Point Cloud Data Packets; see the Motor Speed field in Section 3.1.2.5 Tail .

Sync Angle

Option(s)	Description
Function: OFF (default), ON Sync angle: 0° to 359°	<p>Phase lock angle</p> <p>After enabling this function and specifying a sync angle (i.e. an azimuth), the lidar will rotate to that azimuthal position at the beginning of every full second.</p> <p> Lidar azimuthal position is defined in Section 1.3 Basic structure.</p> <p>Definition of the full second (detailed in Section B.1 Source of absolute time):</p> <ul style="list-style-type: none"> • When PTP is tracking or locked, the full second is retrieved from the PTP signal. (PPS signal is not required nor used.) • When PTP is frozen or in free run, the full second is defined as the rising edge of the lidar's internal 1 Hz signal. <p>To phase-lock multiple lidar units, connect them to the same clock source and set the same sync angle. These lidar units will rotate to the same azimuthal position at every full second.</p>

Trigger Method

Option(s)	Description				
Angle-Based (default) Time-Based	<p>The way laser firings are triggered</p> <table border="1"> <tbody> <tr> <td>Angle-based</td> <td>Lasers fire every 0.1° at 10 Hz (or 0.2° at 20 Hz).</td> </tr> <tr> <td>Time-based</td> <td>Lasers fire every 27.778 μs.</td> </tr> </tbody> </table>	Angle-based	Lasers fire every 0.1° at 10 Hz (or 0.2° at 20 Hz).	Time-based	Lasers fire every 27.778 μs.
Angle-based	Lasers fire every 0.1° at 10 Hz (or 0.2° at 20 Hz).				
Time-based	Lasers fire every 27.778 μs.				

Up-Close Blockage Detection

Option(s)	Description
OFF (default) ON	See Definition of the Distance field .

4.3. State settings**Reset All Settings and Restart**

Option(s)	Description
Reset All Settings and Restart	Reset all the parameters in Section 4.2 Functional settings to factory defaults and then restart the lidar. Afterward, the Start-Up Times in Section 4.6 Operation statistics increments by 1.

Restart

Option(s)	Description
N/A	Afterward, the Start-Up Times in Section 4.6 Operation statistics increments by 1.

Standby Mode

Option(s)	Description
In Operation (default) Standby	In Standby mode, the motor stops running and lasers stop firing.

4.4. Time sync

Read-only parameter	Description	
PTP Status	Free Run	No PTP master is selected.
	Tracking	Attempting to sync with the selected PTP Master, but the absolute offset exceeds the user-specified limit; see PTP Lock Time Offset in this section.
	Locked	The absolute offset is within the user-specified limit.
	Frozen	The lidar has lost connection to the PTP master and is attempting to recover it. Meanwhile, lidar time will drift from the last synchronized time. When the time drift exceeds the specification, PTP status will change to Free Run.

PTP Profile

Option(s)	Description
802.1AS Automotive 802.1AS AUTOSAR (default)	IEEE timing and synchronization standard

PTP Lock Time Offset

Option(s)	Description
1 to 100 μ s (integer) Default: 1	Upper limit of the absolute offset between Slave and Master when the lidar is in PTP Locked status; see PTP Status in this section.

PTP Domain Number

Option(s)	Description
0 to 127 (integer) Default: 0	Domain attribute of the local clock

PTP Network Transport

Option(s)	Description
L2	Network transport protocol

Switch Type

Option(s)	Description				
TSN (default)	Type of the network switch				
Non-TSN	<table border="1"> <tbody> <tr> <td>TSN</td> <td>Time Sensitive Network, using Peer-to-Peer delay mechanism</td> </tr> <tr> <td>Non-TSN</td> <td>Using End-to-End delay mechanism</td> </tr> </tbody> </table>	TSN	Time Sensitive Network, using Peer-to-Peer delay mechanism	Non-TSN	Using End-to-End delay mechanism
TSN	Time Sensitive Network, using Peer-to-Peer delay mechanism				
Non-TSN	Using End-to-End delay mechanism				

4.5. Lidar info

Read-only parameter	Description
SN	Serial Number
PN	Part Number, indicating the lidar's hardware version Format: [Lidar Model]-[Configuration]
MAC address	Media access control (MAC) address Format: XX:XX:XX:XX:XX:XX (hexadecimal)
Lidar Model	OT128

Angle correction file

Option(s)	Description
get file	The angle correction file of each lidar unit is used to correct the azimuth and elevation of each channel.

4.6. Operation statistics

Climatic

- Internal Temperature
- Humidity

Electrical

- Lidar Input Current
- Lidar Input Voltage
- Lidar Input Power

 The electrical parameters are measured at the lidar's external connector.

Availability

- Start-Up Times
- System Uptime
- Total Operation Time

4.7. Upgrade

Upgrade

Option(s)	Description
Upgrade	Upgrade the lidar's firmware and software.

4.8. Logs

Type of log	Description
Operation Log	Record of lidar operations

Type of log	Description
Upgrade Log	Record of firmware/software upgrades
Fault Log	Record of faults for functional safety diagnostics
Command History	Number of commands (by category) that are executed after system start-up

5. Communication protocol

Pandar TCP Commands (PTC) API can be used to communicate with Hesai lidars.

 To acquire the API reference manuals, please contact Hesai technical support.

With cybersecurity enabled, the encrypted **PTCS (PTC over TLS) API** is also available:

- Data format: Same as the cleartext PTC API.
- Requirements: TLS version should be 1.3 or above, with OpenSSL 1.1.1 or above.

 The sample code for using PTCS and point cloud signature can be found at: https://github.com/HesaiTechnology/Cyber_Security

6. Maintenance

The lidar's cover lens is made of plastic (polycarbonate, PC), similar to the material used for car lamps.

- Do NOT wipe the cover lens when it is dry, nor use abrasive cleaners. Doing so can damage the optical coating.
- Do NOT use organic cleaners, which can damage the cover lens and even cause cracking.
 - Organic cleaners include but are not limited to tar removers, self-cleaning agents, adhesive removers, coating removers, foam cleaners, iron powder removers for car paint, glass cleaners, thinning agents, de-icers, paint surface treatment agents, alcohol, and vinegar.
 - Do NOT use automatic car wash equipment to clean the lidar. Before washing the car or performing related operations, protect the cover lens to prevent any contact with organic cleaners.
- Do NOT apply excessive force to the lidar, as this can damage the cover lens.
- If a pressure washer is used to clean the cover lens, make sure the distance between the nozzle and the cover lens remains at least 60 cm.
- After prolonged exposure to strong sunlight and high temperatures, the cover lens should NOT be cleaned immediately.
- If snow or ice accumulates on the cover lens, do NOT use a pressure washer or ice scraper.
 - A small broom is recommended to remove snow.
 - A solvent-free (i.e., free of organic solvents) ice removal spray is recommended to remove ice; alternatively, wait for the ice to melt by itself.
- Do NOT wax the cover lens.



Please regularly check on the cover lens, considering your car use frequency, parking environment, and climate conditions.



- If foreign objects (such as dust, fingerprints, or oil stains) are found on the cover lens, make sure to clean them.
- If corrosive foreign objects (such as insect remains, bird droppings, tree resin, road dust, industrial dust, asphalt, soot particles, and road salt) are found on the cover lens, make sure to clean them immediately.

Cleaning procedure

1. Make sure the lidar is powered OFF.
2. Choose an appropriate cleaning agent:
 - For light stains, use room temperature water.
 - For heavier stains, use a mild soap solution (no more than two tablespoons of soap per quart or liter of water).

- For stubborn stains, use a solvent-free (i.e., free of organic solvents), pH-neutral detergent at room temperature, such as car shampoo.
- 3. Take a clean soft sponge or anti-static microfiber cloth, dampen it with the chosen cleaning agent, and gently wipe the dirty area on the cover lens back and forth.
- 4. For stubborn stains, cover the dirty area with the dampened sponge or cloth to soften the stains before wiping.
- 5. Immediately after removing the stains, rinse the cover lens with clean water. Then, use a clean soft sponge or microfiber cloth to gently wipe away any remaining liquid (which may contain residual cleaning agents or contaminants).

7. Troubleshooting

If the following procedures cannot solve your problem, please contact Hesai technical support.

Indicator light is off on the connection box.

Make sure that the following conditions are met:

- The power adapter is properly connected and in good condition.
- The connection box is intact.
- The input voltage and input current satisfy the requirements in [Section 2.3 Connection box \(optional\)](#).

Afterward, power on the lidar again and check if the symptom persists.

Motor is not running.

Make sure that the following conditions are met:

- The power adapter is properly connected and in good condition.
- The input voltage and input current satisfy the requirements in [Section 1.6 Specifications](#).
- The lidar can be accessed using LidarUtilities (see [The lidar cannot connect to LidarUtilities.](#)).
- The lidar is not in standby mode; this can be confirmed using LidarUtilities or PTC commands.
- If a connection box is used, the connection box is intact.

Afterward, power on the lidar again and check if the symptom persists.

Motor is running, but no output data is received, neither by Wireshark nor by PandarView 2.

Make sure that the following conditions are met:

- The Ethernet cable is properly connected (by unplugging and plugging again).
- Destination IP is correctly set; this can be confirmed using LidarUtilities or PTC commands.
- Firmware version is correct; this can be confirmed using LidarUtilities or PTC commands.

- Azimuth FOV is correctly set; this can be confirmed using LidarUtilities or PTC commands.
- The lidar is emitting laser light; this can be confirmed using an infrared camera, an infrared sensor card, or a phone camera without an infrared filter.
- If a connection box is used, replace the current Ethernet cable with another cable of at least Cat 6; Cat 7 or higher is recommended.

Afterward, power on the lidar again and check if the symptom persists.

Output data can be received by Wireshark but not by PandarView 2.

Make sure that the following conditions are met:

- Lidar Destination Port is correctly set; this can be confirmed using LidarUtilities or PTC commands.
- If VLAN is enabled, the PC's VLAN ID should be the same as the lidar's; this can be checked using LidarUtilities or PTC commands.
- The PC's firewall is disabled, or PandarView 2 is added to the firewall exceptions.
- The latest PandarView 2 is installed (see [Downloads page of Hesai's official website](#) or contact Hesai technical support).

Afterward, power on the lidar again and check if the symptom persists.

The lidar cannot connect to LidarUtilities.

Make sure that the following conditions are met:

- Ethernet cable is properly connected (by unplugging and plugging again).
- The lidar's IP is in the same subnet with the PC's (WireShark may be used to check the lidar's IP that broadcasts data packets).
- If VLAN is enabled, the PC's VLAN ID should be the same as the lidar's; this can be checked using LidarUtilities or PTC commands.

Afterward, follow these steps:

1. Restart the PC or connect the lidar to another PC.
2. Power on the lidar again and check if the symptom persists.

The point cloud is abnormal, showing obviously misaligned points, flashing points, or incomplete FOV.

Make sure that the following conditions are met:

- The lidar's cover lens is clean. If not, refer to [Section 6 Maintenance](#) for the cleaning method.
- The lidar's angle correction file is imported (refer to PandarView 2 User Manual).
- Azimuth FOV is properly set; this can be confirmed using LidarUtilities or PTC commands.
- Spin Rate is steady; this can be confirmed by checking the **Motor Speed** field in the Point Cloud Data Packet, or by using LidarUtilities, PandarView 2 or PTC commands.

Afterward, check for packet loss.

If no packet is lost yet the point cloud flashes, please follow these steps:

1. Update PandarView 2 to the latest version (see [Downloads page of Hesai's official website](#) or contact Hesai technical support).
2. Restart the PC.

If the point cloud is still abnormal, try these steps:

1. Connect the lidar to another PC and another network.
2. Power on again and check if the symptom persists.

The number of data packets received is abnormal, indicating missing packets.

Make sure that the following conditions are met:

- Azimuth FOV is properly set; this can be confirmed using LidarUtilities or PTC commands.
- Spin Rate is steady; this can be confirmed by checking the **Motor Speed** field in the Point Cloud Data Packet, or by using LidarUtilities, PandarView 2 or PTC commands.
- Ethernet is not overloaded.
- No switch is connected to the network (the data transmitted from other devices may cause network congestion and packet loss).

Afterward, follow these steps:

1. Connect the PC to no other devices but the lidar and check for packet loss.

2. Power on the lidar again and check if the symptom persists.

Appendix A: Channel distribution data

Notes to the table

Channel number	Counts from 1, top to bottom.
Angular position	<p>The design values of each channel's horizontal (azimuth) angle offset and vertical (elevation) angle.</p> <ul style="list-style-type: none"> • The accurate values are recorded in this lidar unit's angle correction file. • To analyze point cloud data, refer to Section 3.1.4 Point cloud data analysis method.
Instrumented range	Actual measurement range, confined by the allocated Time of Flight (ToF) for each channel.
Near-field enabled channels	Channels with 0.3 m minimum instrumented range.
Max. range @10% reflectivity	<ul style="list-style-type: none"> • Probability of Detection (PoD) = 70% • Channels 113 to 128 only provide near- and mid-field detection, since these channels typically point to the ground.
Far-field enhanced	Channels 33 to 64 are far-field-enhanced channels , able to detect 200 m @10% (see data in max. range @10% reflectivity).
Min. detectable reflectivity at max. instrumented range	Probability of Detection (PoD) = 70%
High-resolution channels	<p>Channels 25 to 88 are high-res channels, characterized by:</p> <ul style="list-style-type: none"> • 0.125° vertical resolution • enhanced horizontal resolution in High Resolution Mode • Max. instrumented range = 230 m

Channel No.	Angular position		Instrumented range		Near-field enabled?	Max. range @ 10% reflectivity	Far-field enhanced?	Min. detectable reflectivity at max. instrumented range	High-res?
	Horiz. offset	Vertical	Min	Max					
1	0.186°	14.985°	0.3 m	130 m	YES	60 m	-	100%	-
2	0.185°	13.283°	0.3 m	130 m	YES	80 m	-	50%	-
3	1.335°	11.758°	0.3 m	130 m	YES	80 m	-	50%	-
4	1.343°	10.483°	0.3 m	130 m	YES	80 m	-	50%	-
5	0.148°	9.836°	1.4 m	130 m	-	80 m	-	50%	-
6	0.147°	9.171°	0.3 m	130 m	YES	80 m	-	50%	-
7	0.146°	8.496°	1.4 m	130 m	-	100 m	-	35%	-
8	0.146°	7.812°	0.3 m	130 m	YES	100 m	-	35%	-
9	1.335°	7.462°	1.4 m	130 m	-	100 m	-	35%	-
10	1.336°	7.115°	1.4 m	130 m	-	100 m	-	35%	-
11	1.337°	6.767°	1.4 m	130 m	-	100 m	-	35%	-
12	1.338°	6.416°	0.3 m	130 m	YES	100 m	-	35%	-
13	1.339°	6.064°	1.4 m	130 m	-	100 m	-	35%	-
14	1.340°	5.710°	1.4 m	130 m	-	100 m	-	35%	-
15	1.341°	5.355°	1.4 m	130 m	-	100 m	-	35%	-
16	1.342°	4.998°	0.3 m	130 m	YES	100 m	-	35%	-
17	0.128°	4.643°	1.4 m	130 m	-	100 m	-	35%	-
18	0.128°	4.282°	1.4 m	130 m	-	100 m	-	35%	-

Channel No.	Angular position		Instrumented range		Near-field enabled?	Max. range @ 10% reflectivity	Far-field enhanced?	Min. detectable reflectivity at max. instrumented range	High-res?
	Horiz. offset	Vertical	Min	Max					
19	0.127°	3.921°	1.4 m	130 m	-	100 m	-	35%	-
20	0.127°	3.558°	0.3 m	130 m	YES	100 m	-	35%	-
21	0.107°	3.194°	1.4 m	130 m	-	100 m	-	35%	-
22	0.106°	2.829°	1.4 m	130 m	-	100 m	-	35%	-
23	0.105°	2.463°	1.4 m	130 m	-	100 m	-	35%	-
24	0.105°	2.095°	0.3 m	130 m	YES	100 m	-	35%	-
25	-3.118°	1.974°	1.4 m	230 m	-	140 m	-	30%	YES
26	1.315°	1.854°	1.4 m	230 m	-	140 m	-	40%	YES
27	4.529°	1.729°	1.4 m	230 m	-	140 m	-	40%	YES
28	-3.121°	1.609°	1.4 m	230 m	-	140 m	-	40%	YES
29	1.316°	1.487°	1.4 m	230 m	-	140 m	-	40%	YES
30	4.532°	1.362°	1.4 m	230 m	-	140 m	-	40%	YES
31	-3.124°	1.242°	1.4 m	230 m	-	140 m	-	40%	YES
32	1.317°	1.120°	0.3 m	230 m	YES	140 m	-	40%	YES
33	4.536°	0.995°	1.4 m	230 m	-	200 m	YES	20%	YES
34	-3.127°	0.875°	1.4 m	230 m	-	200 m	YES	20%	YES
35	1.317°	0.750°	1.4 m	230 m	-	200 m	YES	20%	YES
36	4.539°	0.625°	1.4 m	230 m	-	200 m	YES	20%	YES

Channel No.	Angular position		Instrumented range		Near-field enabled?	Max. range @ 10% reflectivity	Far-field enhanced?	Min. detectable reflectivity at max. instrumented range	High-res?
	Horiz. offset	Vertical	Min	Max					
37	-3.13°	0.500°	1.4 m	230 m	-	200 m	YES	20%	YES
38	1.318°	0.375°	1.4 m	230 m	-	200 m	YES	20%	YES
39	4.542°	0.250°	0.3 m	230 m	YES	200 m	YES	20%	YES
40	-3.133°	0.125°	1.4 m	230 m	-	200 m	YES	20%	YES
41	0.103°	0°	1.4 m	230 m	-	200 m	YES	20%	YES
42	2.935°	-0.125°	1.4 m	230 m	-	200 m	YES	20%	YES
43	-1.517°	-0.250°	1.4 m	230 m	-	200 m	YES	20%	YES
44	0.103°	-0.375°	1.4 m	230 m	-	200 m	YES	20%	YES
45	2.937°	-0.500°	1.4 m	230 m	-	200 m	YES	20%	YES
46	-1.519°	-0.626°	0.3 m	230 m	YES	200 m	YES	20%	YES
47	0.103°	-0.751°	1.4 m	230 m	-	200 m	YES	20%	YES
48	2.939°	-0.876°	1.4 m	230 m	-	200 m	YES	20%	YES
49	-1.520°	-1.001°	1.4 m	230 m	-	200 m	YES	20%	YES
50	0.103°	-1.126°	1.4 m	230 m	-	200 m	YES	20%	YES
51	2.941°	-1.251°	1.4 m	230 m	-	200 m	YES	20%	YES
52	-1.521°	-1.377°	1.4 m	230 m	-	200 m	YES	20%	YES
53	0.102°	-1.502°	0.3 m	230 m	YES	200 m	YES	20%	YES
54	2.943°	-1.627°	1.4 m	230 m	-	200 m	YES	20%	YES

Channel No.	Angular position		Instrumented range		Near-field enabled?	Max. range @ 10% reflectivity	Far-field enhanced?	Min. detectable reflectivity at max. instrumented range	High-res?
	Horiz. offset	Vertical	Min	Max					
55	-1.523°	-1.751°	1.4 m	230 m	-	200 m	YES	20%	YES
56	0.102°	-1.876°	1.4 m	230 m	-	200 m	YES	20%	YES
57	2.945°	-2.001°	1.4 m	230 m	-	200 m	YES	20%	YES
58	-1.524°	-2.126°	1.4 m	230 m	-	200 m	YES	20%	YES
59	0.102°	-2.251°	1.4 m	230 m	-	200 m	YES	20%	YES
60	2.946°	-2.376°	0.3 m	230 m	YES	200 m	YES	20%	YES
61	-1.526°	-2.501°	1.4 m	230 m	-	200 m	YES	20%	YES
62	0.102°	-2.626°	1.4 m	230 m	-	200 m	YES	20%	YES
63	2.948°	-2.751°	1.4 m	230 m	-	200 m	YES	20%	YES
64	-1.526°	-2.876°	1.4 m	230 m	-	200 m	YES	20%	YES
65	1.324°	-3.001°	1.4 m	230 m	-	140 m	-	40%	YES
66	4.570°	-3.126°	1.4 m	230 m	-	140 m	-	40%	YES
67	-3.155°	-3.251°	0.3 m	230 m	YES	140 m	-	40%	YES
68	1.325°	-3.376°	1.4 m	230 m	-	140 m	-	40%	YES
69	4.573°	-3.501°	1.4 m	230 m	-	140 m	-	40%	YES
70	-3.157°	-3.626°	1.4 m	230 m	-	140 m	-	40%	YES
71	1.326°	-3.751°	1.4 m	230 m	-	140 m	-	40%	YES
72	4.575°	-3.876°	1.4 m	230 m	-	140 m	-	40%	YES

Channel No.	Angular position		Instrumented range		Near-field enabled?	Max. range @ 10% reflectivity	Far-field enhanced?	Min. detectable reflectivity at max. instrumented range	High-res?
	Horiz. offset	Vertical	Min	Max					
73	-3.159°	-4.001°	1.4 m	230 m	-	140 m	-	40%	YES
74	1.326°	-4.126°	0.3 m	230 m	YES	140 m	-	40%	YES
75	4.578°	-4.25°	1.4 m	230 m	-	140 m	-	40%	YES
76	-3.161°	-4.375°	1.4 m	230 m	-	140 m	-	40%	YES
77	1.327°	-4.501°	1.4 m	230 m	-	140 m	-	40%	YES
78	4.581°	-4.626°	1.4 m	230 m	-	140 m	-	40%	YES
79	-3.163°	-4.751°	1.4 m	230 m	-	140 m	-	40%	YES
80	1.328°	-4.876°	0.3 m	230 m	YES	140 m	-	40%	YES
81	4.583°	-5.001°	1.4 m	230 m	-	140 m	-	40%	YES
82	-3.165°	-5.126°	1.4 m	230 m	-	140 m	-	40%	YES
83	1.329°	-5.252°	1.4 m	230 m	-	140 m	-	40%	YES
84	4.586°	-5.377°	1.4 m	230 m	-	140 m	-	40%	YES
85	-3.167°	-5.502°	1.4 m	230 m	-	140 m	-	40%	YES
86	1.329°	-5.626°	1.4 m	230 m	-	140 m	-	40%	YES
87	4.588°	-5.752°	1.4 m	230 m	-	140 m	-	40%	YES
88	-3.168°	-5.877°	1.4 m	230 m	-	140 m	-	40%	YES
89	0.102°	-6.002°	0.3 m	130 m	YES	100 m	-	35%	-
90	0.103°	-6.378°	1.4 m	130 m	-	100 m	-	35%	-

Channel No.	Angular position		Instrumented range		Near-field enabled?	Max. range @ 10% reflectivity	Far-field enhanced?	Min. detectable reflectivity at max. instrumented range	High-res?
	Horiz. offset	Vertical	Min	Max					
91	0.103°	-6.754°	1.4 m	130 m	-	100 m	-	35%	-
92	0.103°	-7.13°	1.4 m	130 m	-	100 m	-	35%	-
93	0.104°	-7.507°	0.3 m	130 m	YES	100 m	-	35%	-
94	0.104°	-7.882°	1.4 m	130 m	-	100 m	-	35%	-
95	0.104°	-8.257°	1.4 m	130 m	-	100 m	-	35%	-
96	0.104°	-8.632°	1.4 m	130 m	-	100 m	-	35%	-
97	1.337°	-9.003°	0.3 m	130 m	YES	100 m	-	35%	-
98	1.337°	-9.376°	1.4 m	130 m	-	100 m	-	35%	-
99	1.338°	-9.749°	1.4 m	130 m	-	100 m	-	35%	-
100	1.339°	-10.121°	1.4 m	130 m	-	100 m	-	35%	-
101	1.340°	-10.493°	0.3 m	130 m	YES	100 m	-	35%	-
102	1.341°	-10.864°	1.4 m	130 m	-	100 m	-	35%	-
103	1.341°	-11.234°	1.4 m	130 m	-	100 m	-	35%	-
104	1.342°	-11.603°	1.4 m	130 m	-	100 m	-	35%	-
105	0.108°	-11.975°	0.3 m	130 m	YES	100 m	-	35%	-
106	0.108°	-12.343°	1.4 m	130 m	-	100 m	-	35%	-
107	0.109°	-12.709°	1.4 m	130 m	-	100 m	-	35%	-
108	0.109°	-13.075°	1.4 m	130 m	-	100 m	-	35%	-

Channel No.	Angular position		Instrumented range		Near-field enabled?	Max. range @ 10% reflectivity	Far-field enhanced?	Min. detectable reflectivity at max. instrumented range	High-res?
	Horiz. offset	Vertical	Min	Max					
109	0.130°	-13.439°	0.3 m	130 m	YES	100 m	-	35%	-
110	0.131°	-13.803°	1.4 m	130 m	-	100 m	-	35%	-
111	0.131°	-14.164°	1.4 m	130 m	-	100 m	-	35%	-
112	0.132°	-14.525°	1.4 m	130 m	-	100 m	-	35%	-
113	1.384°	-14.879°	0.3 m	130 m	YES	80 m	-	50%	-
114	1.384°	-15.237°	1.4 m	130 m	-	80 m	-	50%	-
115	1.385°	-15.593°	1.4 m	130 m	-	80 m	-	50%	-
116	1.385°	-15.948°	1.4 m	130 m	-	80 m	-	50%	-
117	1.386°	-16.299°	0.3 m	130 m	YES	80 m	-	50%	-
118	1.386°	-16.651°	1.4 m	130 m	-	80 m	-	50%	-
119	1.387°	-17.000°	1.4 m	130 m	-	80 m	-	50%	-
120	1.387°	-17.347°	1.4 m	130 m	-	80 m	-	50%	-
121	0.151°	-17.701°	0.3 m	130 m	YES	80 m	-	50%	-
122	0.153°	-18.386°	1.4 m	130 m	-	80 m	-	50%	-
123	0.154°	-19.063°	0.3 m	130 m	YES	80 m	-	50%	-
124	0.156°	-19.730°	1.4 m	130 m	-	80 m	-	50%	-
125	1.388°	-20.376°	0.3 m	130 m	YES	80 m	-	50%	-
126	1.408°	-21.653°	0.3 m	130 m	YES	50 m	-	180%	-

Channel No.	Angular position		Instrumented range		Near-field enabled?	Max. range @ 10% reflectivity	Far-field enhanced?	Min. detectable reflectivity at max. instrumented range	High-res?
	Horiz. offset	Vertical	Min	Max					
127	0.196°	-23.044°	0.3 m	130 m	YES	40 m	-	260%	-
128	0.286°	-24.765°	0.3 m	130 m	YES	30 m	-	600%	-

Appendix B: Absolute time of point cloud data

B.1. Source of absolute time

The lidar retrieves the current absolute time by connecting to an external clock source.

B.1.1. PTP as the clock source

The lidar connects to a third-party PTP master to obtain PTP signal.



- PPS signal is not required nor used.
- PTP can be configured using LidarUtilities or PTC commands.
- The status of PTP signal can be found using LidarUtilities or PTC commands.

The absolute time is updated as follows:

PTP status	Date and time (accurate to the microsecond)	Lidar behavior
Free run	Virtual	Since the lidar has not been locked before, it starts counting from a virtual UTC (such as 2000-01-01 00:00:00) using the lidar's internal 1 Hz signal.
Tracking or Locked	Synchronized	The lidar extracts the actual date and time from the PTP Master's messages.
Frozen	Drifting	When the lidar goes from Tracking/Locked to Frozen, it starts counting from the last synchronized time using the lidar's internal 1 Hz signal. This absolute time will gradually drift from the actual PTP time.



- PTP is a Plug & Play protocol; the lidar works as a PTP slave device and requires no additional setup.
- The **Timestamps** and **Date & Time** fields in Point Cloud Data Packets strictly follow the PTP master device. Certain PTP master devices may have a specified offset from the lidar's time output. Please verify the configuration and calibration of your PTP master device.

B.2. Absolute time of Point Cloud Data Packets

The absolute time of Point Cloud Data Packets is $t_0 = t_s + t_{ms}$, where:

- t_s is the whole second part (see the **Date & Time** field).
- t_{ms} is the microsecond part (see the **Timestamp** field).

The definition of the above fields is in [Section 3.1.2.5 Tail](#).

B.3. Start time of each block

Given the Absolute time of Point Cloud Data Packets as t_0 , the start time of each block (i.e., the time when the first firing starts) can be calculated.

Single return mode

Block	Start time (μs) in High Resolution mode	Start time (μs) in Standard mode
Block 1	$t_0 - 27.778$	$t_0 - 27.778 \times 2$
Block 2	t_0	t_0

Dual return mode

Block	Start time (μs)
Block 1 & Block 2	t_0

High Resolution mode and Standard mode

Mode	Frame rate	Horizontal Resolution of Far Field Measurement
Standard	10 Hz	0.2° for all channels
High Resolution	10 Hz	0.1° for the high-res channels (Channel 25 to Channel 88) 0.2° for the other channels
	20 Hz	0.2° for the high-res channels (Channel 25 to Channel 88) 0.4° for the other channels

B.4. Laser firing time of each channel

Given the start time (see [Section B.3 Start time of each block](#)) of **Block m** is $T(m)$, $m \in \{1, 2\}$, the laser firing time of **Channel n: Block m** is

$$t(m, n) = T(m) + \Delta t(n), n \in \{1, 2, \dots, 128\}$$

Steps to look up firing time offsets $\Delta t(n)$

1. Check the **Operational State** field in the **Tail** of the Point Cloud Data Packet.
 - Operation States: High Resolution, Standard, and Shutdown
2. Check the **Azimuth State** field in the **Tail** of the Point Cloud Data Packet, and obtain the azimuth state of Block m.
 - Range:
 - 0 to 1 (Standard mode)
 - 0 to 3 (High Resolution mode)
3. Look up $\Delta t(n)$ in the tables below
Unit: μs

In the ascending order of channel number (High Resolution)

Channel No.	Azimuth State				Channel No.	Azimuth State			
	0	1	2	3		0	1	2	3
1	-	18.867	-	18.867	65	14.231	14.231	16.375	14.231
2	-	6.289	-	6.289	66	16.549	16.549	18.693	16.549
3	18.867	-	21.011	-	67	20.52	20.52	22.664	20.52
4	6.289	-	6.289	-	68	7.942	7.942	7.942	7.942
5	-	12.578	-	12.578	69	10.26	10.26	10.26	10.26
6	-	0	-	0	70	16.549	16.549	18.693	16.549
7	12.578	-	14.722	-	71	1.653	1.653	1.653	1.653
8	0	-	0	-	72	3.971	3.971	3.971	3.971
9	-	18.867	-	18.867	73	10.26	10.26	10.26	10.26
10	-	6.289	-	6.289	74	22.838	22.838	24.982	22.838
11	18.867	-	21.011	-	75	14.231	14.231	16.375	14.231
12	6.289	-	6.289	-	76	3.971	3.971	3.971	3.971
13	-	12.578	-	12.578	77	20.52	20.52	22.664	20.52
14	-	0	-	0	78	7.942	7.942	7.942	7.942
15	12.578	-	14.722	-	79	14.231	14.231	16.375	14.231
16	0	-	0	-	80	16.549	16.549	18.693	16.549
17	-	18.867	-	18.867	81	1.653	1.653	1.653	1.653
18	-	6.289	-	6.289	82	7.942	7.942	7.942	7.942
19	18.867	-	21.011	-	83	10.26	10.26	10.26	10.26

B.4. Laser firing time of each channel

Channel No.	Azimuth State				Channel No.	Azimuth State			
	0	1	2	3		0	1	2	3
20	6.289	-	6.289	-	84	22.838	22.838	24.982	22.838
21	-	12.578	-	12.578	85	1.653	1.653	1.653	1.653
22	-	0	-	0	86	3.971	3.971	3.971	3.971
23	12.578	-	14.722	-	87	20.52	20.52	22.664	20.52
24	0	-	0	-	88	22.838	22.838	24.982	22.838
25	20.52	20.52	22.664	20.52	89	-	18.867	-	18.867
26	16.549	16.549	18.693	16.549	90	-	6.289	-	6.289
27	10.26	10.26	10.26	10.26	91	18.867	-	21.011	-
28	16.549	16.549	18.693	16.549	92	6.289	-	6.289	-
29	20.52	20.52	22.664	20.52	93	-	12.578	-	12.578
30	3.971	3.971	3.971	3.971	94	-	0	-	0
31	14.231	14.231	16.375	14.231	95	12.578	-	14.722	-
32	7.942	7.942	7.942	7.942	96	0	-	0	-
33	14.231	14.231	16.375	14.231	97	-	18.867	-	18.867
34	7.942	7.942	7.942	7.942	98	-	6.289	-	6.289
35	10.26	10.26	10.26	10.26	99	18.867	-	21.011	-
36	1.653	1.653	1.653	1.653	100	6.289	-	6.289	-
37	1.653	1.653	1.653	1.653	101	-	12.578	-	12.578
38	3.971	3.971	3.971	3.971	102	-	0	-	0
39	22.838	22.838	24.982	22.838	103	12.578	-	14.722	-

B.4. Laser firing time of each channel

Channel No.	Azimuth State				Channel No.	Azimuth State			
	0	1	2	3		0	1	2	3
40	22.838	22.838	24.982	22.838	104	0	-	0	-
41	14.231	14.231	16.375	14.231	105	-	18.867	-	18.867
42	16.549	16.549	18.693	16.549	106	-	6.289	-	6.289
43	20.52	20.52	22.664	20.52	107	18.867	-	21.011	-
44	7.942	7.942	7.942	7.942	108	6.289	-	6.289	-
45	10.26	10.26	10.26	10.26	109	-	12.578	-	12.578
46	16.549	16.549	18.693	16.549	110	-	0	-	0
47	1.653	1.653	1.653	1.653	111	12.578	-	14.722	-
48	3.971	3.971	3.971	3.971	112	0	-	0	-
49	10.26	10.26	10.26	10.26	113	-	18.867	-	18.867
50	22.838	22.838	24.982	22.838	114	-	6.289	-	6.289
51	14.231	14.231	16.375	14.231	115	18.867	-	21.011	-
52	3.971	3.971	3.971	3.971	116	6.289	-	6.289	-
53	20.52	20.52	22.664	20.52	117	-	12.578	-	12.578
54	7.942	7.942	7.942	7.942	118	-	0	-	0
55	14.231	14.231	16.375	14.231	119	12.578	-	14.722	-
56	16.549	16.549	18.693	16.549	120	0	-	0	-
57	1.653	1.653	1.653	1.653	121	-	18.867	-	18.867
58	7.942	7.942	7.942	7.942	122	-	6.289	-	6.289
59	10.26	10.26	10.26	10.26	123	18.867	-	21.011	-

B.4. Laser firing time of each channel

Channel No.	Azimuth State				Channel No.	Azimuth State			
	0	1	2	3		0	1	2	3
60	22.838	22.838	24.982	22.838	124	6.289	-	6.289	-
61	1.653	1.653	1.653	1.653	125	-	12.578	-	12.578
62	3.971	3.971	3.971	3.971	126	-	0	-	0
63	20.52	20.52	22.664	20.52	127	12.578	-	14.722	-
64	22.838	22.838	24.982	22.838	128	0	-	0	-

In the ascending order of channel number (Standard)

Channel No.	Azimuth State		Channel No.	Azimuth State	
	0	1		0	1
1	46.645	46.645	65	14.231	16.375
2	34.067	34.067	66	16.549	18.693
3	18.867	21.011	67	20.52	22.664
4	6.289	6.289	68	7.942	7.942
5	40.356	40.356	69	10.26	10.26
6	27.778	27.778	70	16.549	18.693
7	12.578	14.722	71	1.653	1.653
8	0	0	72	3.971	3.971
9	46.645	46.645	73	10.26	10.26
10	34.067	34.067	74	22.838	24.982
11	18.867	21.011	75	14.231	16.375
12	6.289	6.289	76	3.971	3.971
13	40.356	40.356	77	20.52	22.664
14	27.778	27.778	78	7.942	7.942
15	12.578	14.722	79	14.231	16.375
16	0	0	80	16.549	18.693
17	46.645	46.645	81	1.653	1.653
18	34.067	34.067	82	7.942	7.942
19	18.867	21.011	83	10.26	10.26

B.4. Laser firing time of each channel

Channel No.	Azimuth State		Channel No.	Azimuth State	
	0	1		0	1
20	6.289	6.289	84	22.838	24.982
21	40.356	40.356	85	1.653	1.653
22	27.778	27.778	86	3.971	3.971
23	12.578	14.722	87	20.52	22.664
24	0	0	88	22.838	24.982
25	20.52	22.664	89	46.645	46.645
26	16.549	18.693	90	34.067	34.067
27	10.26	10.26	91	18.867	21.011
28	16.549	18.693	92	6.289	6.289
29	20.52	22.664	93	40.356	40.356
30	3.971	3.971	94	27.778	27.778
31	14.231	16.375	95	12.578	14.722
32	7.942	7.942	96	0	0
33	14.231	16.375	97	46.645	46.645
34	7.942	7.942	98	34.067	34.067
35	10.26	10.26	99	18.867	21.011
36	1.653	1.653	100	6.289	6.289
37	1.653	1.653	101	40.356	40.356
38	3.971	3.971	102	27.778	27.778
39	22.838	24.982	103	12.578	14.722

B.4. Laser firing time of each channel

Channel No.	Azimuth State		Channel No.	Azimuth State	
	0	1		0	1
40	22.838	24.982	104	0	0
41	14.231	16.375	105	46.645	46.645
42	16.549	18.693	106	34.067	34.067
43	20.52	22.664	107	18.867	21.011
44	7.942	7.942	108	6.289	6.289
45	10.26	10.26	109	40.356	40.356
46	16.549	18.693	110	27.778	27.778
47	1.653	1.653	111	12.578	14.722
48	3.971	3.971	112	0	0
49	10.26	10.26	113	46.645	46.645
50	22.838	24.982	114	34.067	34.067
51	14.231	16.375	115	18.867	21.011
52	3.971	3.971	116	6.289	6.289
53	20.52	22.664	117	40.356	40.356
54	7.942	7.942	118	27.778	27.778
55	14.231	16.375	119	12.578	14.722
56	16.549	18.693	120	0	0
57	1.653	1.653	121	46.645	46.645
58	7.942	7.942	122	34.067	34.067
59	10.26	10.26	123	18.867	21.011

B.4. Laser firing time of each channel

Channel No.	Azimuth State		Channel No.	Azimuth State	
	0	1		0	1
60	22.838	24.982	124	6.289	6.289
61	1.653	1.653	125	40.356	40.356
62	3.971	3.971	126	27.778	27.778
63	20.52	22.664	127	12.578	14.722
64	22.838	24.982	128	0	0

Appendix C: Nonlinear reflectivity mapping

By default, the **Reflectivity** field in Point Cloud Data Packets (see [Section 3.1.2.3 Body](#)) linearly represents target reflectivity.

- Range of the **Reflectivity** field value: 0 to 255
- Range of target reflectivity: 0 to 255%

Alternatively, users may choose the Nonlinear Mapping mode using LidarUtilities or PTC commands.

C.1. Nonlinear Mapping 1#

This mapping increases the contrast in the low-reflectivity region.

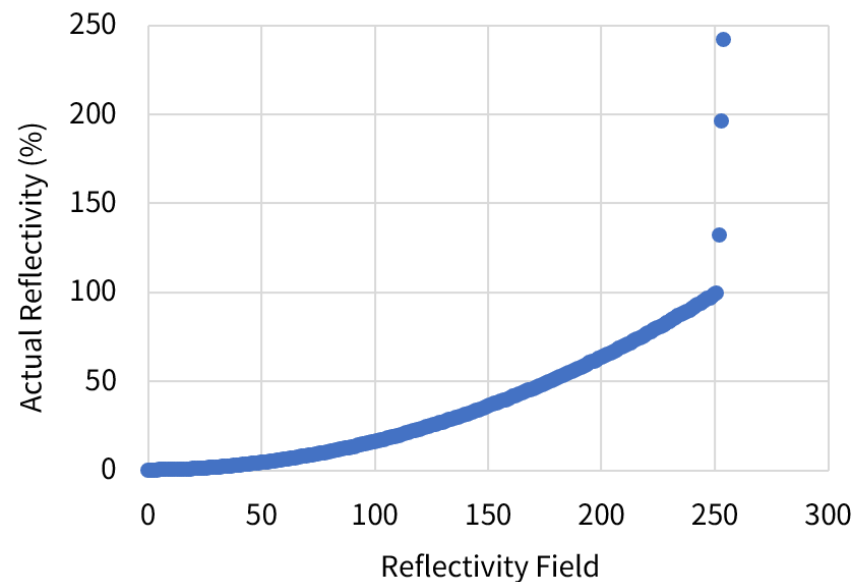

Figure 22. Nonlinear mapping 1#

Nonlinear mapping 1#

Reflectivity field	Actual reflectivity %	Reflectivity field	Actual reflectivity %	Reflectivity field	Actual reflectivity %	Reflectivity field	Actual reflectivity %
0	0	1	0.01	2	0.02	3	0.03
4	0.04	5	0.05	6	0.08	7	0.11
8	0.13	9	0.15	10	0.19	11	0.23
12	0.26	13	0.29	14	0.34	15	0.39
16	0.44	17	0.5	18	0.56	19	0.61
20	0.67	21	0.75	22	0.81	23	0.87
24	0.95	25	1.05	26	1.15	27	1.25
28	1.35	29	1.45	30	1.55	31	1.65
32	1.75	33	1.85	34	1.95	35	2.06
36	2.19	37	2.31	38	2.44	39	2.56
40	2.69	41	2.81	42	2.94	43	3.07
44	3.21	45	3.36	46	3.5	47	3.64
48	3.79	49	3.93	50	4.08	51	4.25
52	4.42	53	4.58	54	4.75	55	4.92
56	5.1	57	5.3	58	5.5	59	5.7
60	5.9	61	6.1	62	6.3	63	6.5
64	6.7	65	6.9	66	7.1	67	7.3
68	7.5	69	7.7	70	7.9	71	8.12
72	8.37	73	8.62	74	8.87	75	9.1

Reflectivity field	Actual reflectivity %	Reflectivity field	Actual reflectivity %	Reflectivity field	Actual reflectivity %	Reflectivity field	Actual reflectivity %
76	9.3	77	9.5	78	9.7	79	9.9
80	10.17	81	10.5	82	10.83	83	11.12
84	11.37	85	11.62	86	11.87	87	12.12
88	12.37	89	12.62	90	12.87	91	13.17
92	13.5	93	13.83	94	14.17	95	14.5
96	14.83	97	15.12	98	15.37	99	15.62
100	15.87	101	16.17	102	16.5	103	16.83
104	17.17	105	17.5	106	17.83	107	18.17
108	18.5	109	18.83	110	19.17	111	19.5
112	19.83	113	20.25	114	20.75	115	21.17
116	21.5	117	21.83	118	22.17	119	22.5
120	22.83	121	23.25	122	23.75	123	24.17
124	24.5	125	24.83	126	25.25	127	25.75
128	26.17	129	26.5	130	26.83	131	27.25
132	27.75	133	28.17	134	28.5	135	28.83
136	29.25	137	29.75	138	30.25	139	30.75
140	31.17	141	31.5	142	31.83	143	32.25
144	32.75	145	33.25	146	33.75	147	34.25
148	34.75	149	35.25	150	35.75	151	36.25
152	36.75	153	37.25	154	37.75	155	38.25

Reflectivity field	Actual reflectivity %	Reflectivity field	Actual reflectivity %	Reflectivity field	Actual reflectivity %	Reflectivity field	Actual reflectivity %
156	38.75	157	39.17	158	39.5	159	39.83
160	40.5	161	41.25	162	41.75	163	42.25
164	42.75	165	43.25	166	43.75	167	44.25
168	44.75	169	45.25	170	45.75	171	46.25
172	46.75	173	47.25	174	47.75	175	48.25
176	48.75	177	49.5	178	50.25	179	50.75
180	51.25	181	51.75	182	52.25	183	52.75
184	53.5	185	54.25	186	54.75	187	55.25
188	55.75	189	56.5	190	57.25	191	57.75
192	58.25	193	58.75	194	59.5	195	60.25
196	60.75	197	61.25	198	61.75	199	62.5
200	63.25	201	63.75	202	64.5	203	65.25
204	65.75	205	66.25	206	66.75	207	67.5
208	68.25	209	68.75	210	69.5	211	70.25
212	70.75	213	71.5	214	72.25	215	72.75
216	73.5	217	74.25	218	74.75	219	75.5
220	76.5	221	77.25	222	77.75	223	78.5
224	79.25	225	79.75	226	80.5	227	81.25
228	81.75	229	82.5	230	83.5	231	84.25
232	84.75	233	85.5	234	86.5	235	87.25

Reflectivity field	Actual reflectivity %	Reflectivity field	Actual reflectivity %	Reflectivity field	Actual reflectivity %	Reflectivity field	Actual reflectivity %
236	87.75	237	88.5	238	89.25	239	89.75
240	90.5	241	91.5	242	92.5	243	93.25
244	93.75	245	94.5	246	95.5	247	96.25
248	96.75	249	97.5	250	98.5	251	99.5
252	132	253	196	254	242	-	-

C.2. Nonlinear mapping 2#

This mapping increases the resolution of low-reflectivity objects, especially lane markings.

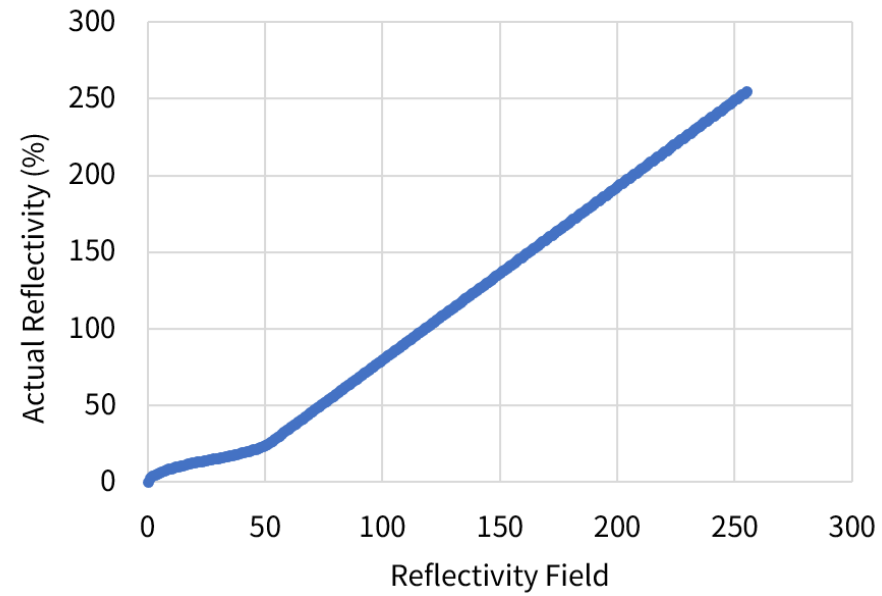

Figure 23. Nonlinear mapping 2#

Nonlinear mapping 2#

Reflectivity field	Actual reflectivity %	Reflectivity field	Actual reflectivity %	Reflectivity field	Actual reflectivity %	Reflectivity field	Actual reflectivity %
0	0	1	2.89	2	4.08	3	5
4	5.77	5	6.45	6	7.07	7	7.64
8	8.16	9	8.66	10	9.13	11	9.57
12	10	13	10.41	14	10.8	15	11.18
16	11.55	17	11.9	18	12.25	19	12.58
20	12.91	21	13.23	22	13.54	23	13.84
24	14.14	25	14.43	26	14.72	27	15
28	15.28	29	15.57	30	15.86	31	16.16
32	16.46	33	16.77	34	17.09	35	17.42
36	17.75	37	18.1	38	18.45	39	18.82
40	19.2	41	19.59	42	20	43	20.43
44	20.87	45	21.34	46	21.84	47	22.36
48	22.93	49	23.55	50	24.23	51	25
52	25.92	53	27.09	54	28.22	55	29.35
56	30.47	57	31.6	58	32.73	59	33.86
60	34.99	61	36.12	62	37.25	63	38.37
64	39.5	65	40.63	66	41.76	67	42.89
68	44.02	69	45.15	70	46.28	71	47.4
72	48.53	73	49.66	74	50.79	75	51.92

Reflectivity field	Actual reflectivity %	Reflectivity field	Actual reflectivity %	Reflectivity field	Actual reflectivity %	Reflectivity field	Actual reflectivity %
76	53.05	77	54.18	78	55.3	79	56.43
80	57.56	81	58.69	82	59.82	83	60.95
84	62.08	85	63.21	86	64.33	87	65.46
88	66.59	89	67.72	90	68.85	91	69.98
92	71.11	93	72.23	94	73.36	95	74.49
96	75.62	97	76.75	98	77.88	99	79.01
100	80.14	101	81.26	102	82.39	103	83.52
104	84.65	105	85.78	106	86.91	107	88.04
108	89.16	109	90.29	110	91.42	111	92.55
112	93.68	113	94.81	114	95.94	115	97.07
116	98.19	117	99.32	118	100.45	119	101.58
120	102.71	121	103.84	122	104.97	123	106.09
124	107.22	125	108.35	126	109.48	127	110.61
128	111.74	129	112.87	130	114	131	115.12
132	116.25	133	117.38	134	118.51	135	119.64
136	120.77	137	121.9	138	123.02	139	124.15
140	125.28	141	126.41	142	127.54	143	128.67
144	129.8	145	130.93	146	132.05	147	133.18
148	134.31	149	135.44	150	136.57	151	137.7
152	138.83	153	139.95	154	141.08	155	142.21

Reflectivity field	Actual reflectivity %	Reflectivity field	Actual reflectivity %	Reflectivity field	Actual reflectivity %	Reflectivity field	Actual reflectivity %
156	143.34	157	144.47	158	145.6	159	146.73
160	147.86	161	148.98	162	150.11	163	151.24
164	152.37	165	153.5	166	154.63	167	155.76
168	156.88	169	158.01	170	159.14	171	160.27
172	161.4	173	162.53	174	163.66	175	164.79
176	165.91	177	167.04	178	168.17	179	169.3
180	170.43	181	171.56	182	172.69	183	173.81
184	174.94	185	176.07	186	177.2	187	178.33
188	179.46	189	180.59	190	181.72	191	182.84
192	183.97	193	185.1	194	186.23	195	187.36
196	188.49	197	189.62	198	190.74	199	191.87
200	193	201	194.13	202	195.26	203	196.39
204	197.52	205	198.65	206	199.77	207	200.9
208	202.03	209	203.16	210	204.29	211	205.42
212	206.55	213	207.67	214	208.8	215	209.93
216	211.06	217	212.19	218	213.32	219	214.45
220	215.58	221	216.7	222	217.83	223	218.96
224	220.09	225	221.22	226	222.35	227	223.48
228	224.6	229	225.73	230	226.86	231	227.99
232	229.12	233	230.25	234	231.38	235	232.51

Reflectivity field	Actual reflectivity %	Reflectivity field	Actual reflectivity %	Reflectivity field	Actual reflectivity %	Reflectivity field	Actual reflectivity %
236	233.63	237	234.76	238	235.89	239	237.02
240	238.15	241	239.28	242	240.41	243	241.53
244	242.66	245	243.79	246	244.92	247	246.05
248	247.18	249	248.31	250	249.44	251	250.56
252	251.69	253	252.82	254	253.95	255	255.08

Appendix D: Legal notice

Copyright © 2017-2024 Hesai Technology Co., Ltd.

All rights reserved. Use or reproduction of this manual in parts or in its entirety without the authorization of Hesai is prohibited.

Hesai Technology makes no representations or warranties, either expressed or implied, with respect to the contents hereof and specifically disclaims any warranties, merchantability, or fitness for any particular purpose. Further, Hesai Technology reserves the right to revise this publication and to make changes from time to time in the contents hereof without obligation to notify any person of such revisions or changes.

HESAI and HESAI logo are registered trademarks of Hesai Technology. All other trademarks, service marks, and company names in this manual or on Hesai's official website are properties of their respective owners.

The software included in this product contains the copyright that is registered under Hesai Technology. Any third party is not permitted, except as expressly permitted by the licensor or expressly required by applicable law, to decompile, reverse engineer, disassemble, modify, rent, lease, loan, distribute, sublicense, create derivative works based on the whole or any part of the software.

Hesai Product Warranty Service Manual is on the Warranty Policy page of Hesai's official website: <https://www.hesaitech.com/warranty-policy/>

Hesai Technology Co., Ltd.

Phone: +86 400 805 1233

Website: www.hesaitech.com

Address: Building A, Haisu Culture Plaza, Shanghai, China

Business Email: info@hesaitech.com

Service Email: service@hesaitech.com